

DECEMBER 1928

25¢

RADIO



IN THIS ISSUE

Short Wave Superheterodyne

Radio Picture Reception

Overcoming Volume Control Difficulties

Helps For The Radio Trouble-Finder



MAGNAVOX *Dynamic* SPEAKERS



*The Christmas Spirit
is in the air!*

The Aristocrat

Beautiful burr burl walnut cabinet finished in two tones.
For A-Battery Operation . . . \$60
For AC Operation \$70



The Belvedere

Two-tone walnut floor screen
For A-Battery Operation . . . \$45
For AC Operation \$55

Units only; DC \$30; AC \$40

**"FIRST
SPEAKER
FIRST
DYNAMIC"**

LICENSED APPARATUS
DYNAMIC
THE MARK OF THE GENUINE

Many Dynamics but all have sprung from Magnavox—the original—the kind used by leading set manufacturers—the dependable one for you to buy. Rich, full reproduction with sweeping volume . . . every tone vividly distinct.

THE MAGNAVOX COMPANY

Oakland, California Chicago, Illinois



In the Sets Designed by Leading Engineers

Faradon Capacitors are specified as standard equipment where electrostatic condenser long life and durability is essential.

Faradon Capacitors mark quality. Keep this in mind when considering a new set, kit or replacement parts.

WIRELESS SPECIALTY APPARATUS CO.

Jamaica Plain, Boston, Mass., U. S. A.

Established 1907

Faradon

Electrostatic Condensers for All Purposes

2202

Tell them you saw it in RADIO

1

RADIO

Established 1917

Published Monthly by the Pacific Radio Publishing Co.

ARTHUR H. HALLORAN, Editor
H. W. DICKOW, Business Manager

P. S. LUCAS, Associate Editor
A. I. RIVETT, Draughtsman

FRANK C. JONES, Technical Advisor

Entered as second-class matter at Post Office at San Francisco, Calif.

Copyright 1928 by the Pacific Radio Publishing Co.

Address all communications to

PACIFIC RADIO PUBLISHING COMPANY
Pacific Building, San Francisco, California

VOL. X DECEMBER, 1928 No. 12

CONTENTS

RADIOTORIAL COMMENT	9
WLW'S 50,000 WATT TRANSMITTER	11
HIGH FREQUENCY ELECTRIC FURNACES	12
<i>By Paul W. Hermann</i>	
BROADCASTING IN PARIS	13
<i>By R. Raven-Hart</i>	
A SHORT-WAVE SUPERHETERODYNE	14
<i>By R. Wm. Tanner</i>	
EXPERIMENTING WITH THE GRID LEAK	16
<i>By L. W. Hatry</i>	
RADIO PICTURE TRANSMISSION AND RECEPTION	17
<i>By John P. Arnold</i>	
THE JENKINS RADIOVISOR	18
<i>By C. Francis Jenkins</i>	
HOW TO OVERCOME VOLUME CONTROL DIFFICULTIES	19
<i>By Frank C. Jones</i>	
THE R. F. CHOKE	20
<i>By Glenn H. Browning</i>	
HELP FOR THE RADIO TROUBLESHOOTER	21
<i>By J. Garrick Eisenberg</i>	
TECHNICAL BRIEFS	23
INSIDE STORIES OF FACTORY-BUILT RECEIVERS	25
RADIO KIT REVIEWS	26
WITH THE AMATEUR OPERATORS	29
THE COMMERCIAL BRASSPOUNDER	30

FORECAST FOR JANUARY ISSUE

Frank C. Jones discusses the dynamic loud speaker. John P. Arnold describes the use of light-sensitive cells in visual communication, the Rayfoto system of still picture reception, and a neon-lamp stroboscope. J. G. Eisenberg continues his "Help for the Radio Trouble Shooter." D. L. Bedingfield completely outlines the design of low-loss inductance coils. Glenn E. West instructs in calibrating a wavemeter from 5 to 90 meters. G. F. Lampkin's promised article on the construction of a crystal-controlled transmitter is definitely scheduled for this issue. If space permits, C. A. Kuhlman's nomograph chart for determining the constants of band-pass filters will be printed. Some unusually interesting material will appear in the "Technical Briefs" and "Commercial Brasspounder" departments.

"YOU CAN FORGET THE CONDENSERS, IF THEY ARE DUBILIER'S"



**cr-r-rack
cr-r-rash!**

Eliminate Interference with one of these Devices

The advent of partial and complete electrification of radio sets has brought about new problems resulting from the picking up of stray power line noises.

These scientifically designed interference eliminators will make your set operate as quietly as with batteries.

Types 1 (\$5.00) and 2 (\$7.50) are of condenser design; the No. 2 unit having double the No. 1 capacity.

Type 3 makes use of a specially designed filter net work. This unit

because of its highly developed choke coil and shunt condenser system has wonderfully fine filter characteristics. Price \$15.00.

Dubilier Light Socket Aerial

"A Moulded Bakelite Product"

A simple device plugged into any light socket—does away with aeriols and lightning arrestors. Will work on any set. No current consumed. If your dealer can't supply you, write to us direct. Price \$1.50.



Dubilier

CONDENSER CORPORATION

10 East 43rd Street, New York City

Address
Dept. 21



for free
catalog

An Xmas Gift For Your Friends —at a great saving to you

Send us \$2.50 and we will send both "RADIO" and "CITIZENS RADIO CALL BOOK" for 1 year to your radio friend as an Xmas gift from you. Radio magazines are ideal holiday gifts. Send both magazines for a full year to your friend for the price of a subscription to "RADIO" alone. \$2.50 covers the entire cost of this offer. We will send a card to your friend, telling him that he is receiving these magazines from you as a Christmas gift. Clip this coupon now—mail it to us with your check or money order for \$2.50 and we will do the rest.

Name of person to whom you want us to send these two magazines _____

His address _____

Name of person sending us this subscription _____

Address _____

Tell them you saw it in RADIO

164 PAGES

This big catalog places before you one of the country's largest — and most complete stock of radio kits, parts, accessories and consoles as well as one the season's outstanding lines of both A.C and D.C. receivers. Every set builder — every dealer, in fact all those interested in radio should send for their copy of this immense catalog.

WHOLESALE PRICES

On Everything in RADIO

RADIO

MODERN RADIO SETS
ACCESSORIES KITS AND PARTS

1929

CONFIDENTIAL
WHOLESALE
PRICES

ALLIED RADIO CORPORATION

711 W. LAKE ST. - CHICAGO, ILL.

RADIO SERVICE

Allied Service will prove a revelation to you in what radio service can really be. Allied Executives backed by years of training in radio, are practical men. They know radio. Their vast experience has built up around them an organization trained to serve. Months of effort have built up a tremendous reserve of stock that makes for prompt shipments; and this stock is new stock comprising the season's pick of such prominent manufacturers as Silver-Marshall, Tyrman, Aero, Hammerlund-Roberts, etc.

SET BUILDERS!

Set Builders, Amateurs and so-called "Hams" will delight in the *unusual variety and remarkable values* that are offered in standard kits and parts. Tremendous stocks—*real organization*—prompt shipping service all combine to make Allied your ideal source of supply.

RADIO DEALERS!

The live radio dealer—the man who keeps pace with the rapid advance of radio—will find much of *real interest* in the Allied Catalog. New A-C Sets, D-C Sets, Dynamic and Magnetic Speakers, Television equipment, in fact everything an impatient radio public is demanding.

Write for Catalog Now!

Allied Radio CORPORATION

711 W. LAKE ST. Dept. E3 CHICAGO



Reap Big Dividends from this Investment in Tone Quality

A Thordarson Power Amplifier (Home Constructed) Will Transform Your Radio Into a Real Musical Instrument

WITH the insistent demand for quality reproduction, power amplification has become a vital radio necessity. Today, it is hard to find a radio set manufacturer who does not employ one or more power tubes in the output stage of his receiver.

There is no need, however, for you to discard your present radio instrument in spite of the fact that it is out-classed by newer models with power amplification. You can build a Thordarson Power Amplifier which, attached to your receiver, will provide a fullness and richness of reproduction that will equal or surpass the finest offerings of the present season.

Thordarson Power Amplifiers are exceedingly easy to assemble, even for the man with no previous radio experience. Only the simplest tools are used. Specific instructions with clear-cut photographs, layouts and diagrams insure success in home construction.

Whether your present receiver is factory made or custom built one of these amplifiers may be attached with equal ease. In fact, most Thordarson Amplifiers require absolutely no changes in

the wiring of the receiver itself, attachment being made by means of a special plug which fits the last audio socket of the receiver.

Thordarson Power Amplifiers for the home constructor and professional set builder range from the simple plate supply unit up to the heavy-duty three stage units employing the 250 type power tube in push-pull arrangement. These power amplifiers cover the requirements for every purpose and every pocket-book. They may be used with any type of horn, cone or dynamic speaker.

With a background of over thirty-three years manufacturing quality transformers, it is only natural that so many manufacturers of receiving sets of undisputed superiority have turned to Thordarson as the logical source of their audio and power supply transformers. The discriminating home constructor will do well to follow the lead of these manufacturers when buying his power amplifier.

Write to the factory today, enclosing 25c for the new "Power Amplifier Manual"—just off the press.

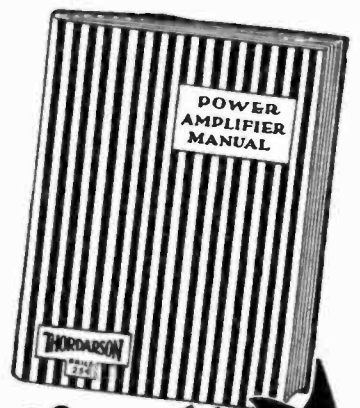

New!

No Amateur or Professional Set Builder Should Be Without This Book—

"POWER AMPLIFIER MANUAL"

A simple, yet complete, treatise on the subject of audio and power amplification, including full information on building, servicing, and testing power amplifiers in general. Also contains detailed specific construction data on twelve individual power units, with clear-cut layouts and diagrams of each.

25c

Send 25c in Cash or Stamps for This New Book—
Just Off the Press!

MAIL THIS COUPON TO-DAY!

THORDARSON ELECTRIC MANUFACTURING CO.
500 West Huron Street, Chicago, Illinois

Gentlemen: Please send me your new "Power Amplifier Manual" for which I am enclosing 25c.

Please send me free of charge your instruction sheet on the amplifier I have checked below:

171 Single 171 Push-Pull 210 Single 210 Push-Pull (1 Stage) 210 Push-Pull (2 Stage) 250 Single (1 Stage) 250 Single (2 Stage) 250 Push-Pull (3 Stage) 210 Phonograph Amplifier

Name.....

Street and No.....

Town..... State.....

3588 G

THORDARSON RADIO TRANSFORMERS

SUPREME IN MUSICAL PERFORMANCE

**THE
NEW
5000 HOUR
ELKON
METALLIC RECTIFIER
FOR
"B" ELIMINATORS**

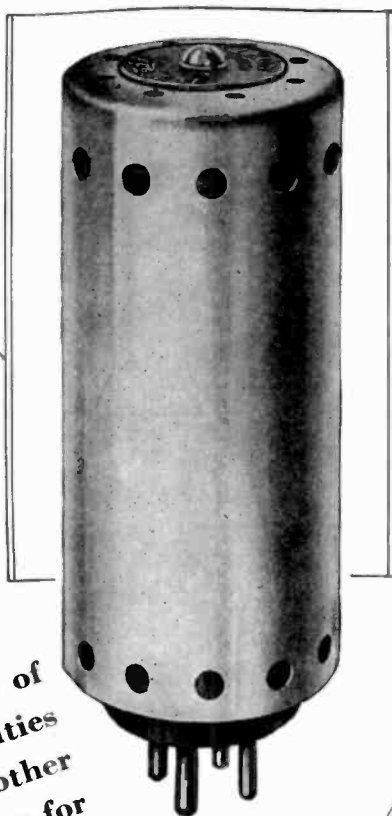

At last a dry high-voltage rectifier! All of the advantages of a tube—none of its frailties—much longer life—more efficient—smoother power—no noise—now as perfect a rectifier for the "B" end as the Elkton "A" Rectifier—stand the Elkton Rectifiers are Self-Healing—surges or accidental overloads are automatically taken care of—no permanent injury is done.

The Elkton EBH replaces BH type tubes in "B" Eliminators. Simply take out the fragile 1000 hour tube and plug in the husky Elkton EBH 5000 hour Rectifier. Same characteristics, but what an improvement.

Use the Elkton EBH Rectifier! Eliminate all uncertainty of life, of successful operation. Build your own new "B" Eliminator or convert the one you have to up-to-the-minute radio efficiency.

Radio Department
ELKON, Inc.
Division of P. R. Mallory & Co., Inc.
350 Madison Ave., New York City

ASK ABOUT THE OTHER ELKON RECTIFIERS, TOO
M-16 for "A" Eliminators and 3 ampere chargers.
V-4 for trickle chargers—and the authorized Halcite Replacement Rectifiers
BNK and BJ.



ELKON, Inc., Radio Department, Dept. E-35
350 Madison Ave., New York City
Kindly send me complete information on Elkton Quality Radio Products.

Name
Address

Tell them you saw it in RADIO

Jensen

DYNAMIC SPEAKER



SINCE Peter L. Jensen first announced the Jensen Dynamic Speaker a year ago, reams have been printed and superlatives exhausted in the announcement of dynamic speakers. But they have all served a good purpose, for by their claims they have established, more than ever, trade and public appreciation of Jensen "reproduction true as the original." It is one thing to make extravagant claims but quite another matter to establish them so firmly that they become a trade asset for the dealer.

It is fitting that the cabinets housing Jensen reproducing units should be correct from an acoustical standpoint and so distinctively beautiful in style and design. (The new Jensen Model 6 Cabinet is illustrated above).

Those dealers handling radio receivers not yet equipped with a dynamic speaker can meet competition by equipping their own consoles with the Jensen Dynamic Speaker—and at a price allowing an attractive return.

JENSEN RADIO MANUFACTURING COMPANY

212 Ninth Street, OAKLAND, CAL.

338 N. Kedzie Avenue, CHICAGO, ILL.

Jensen Patents Allowed and Pending—Licensed under Lektophone and Magnavox Patents

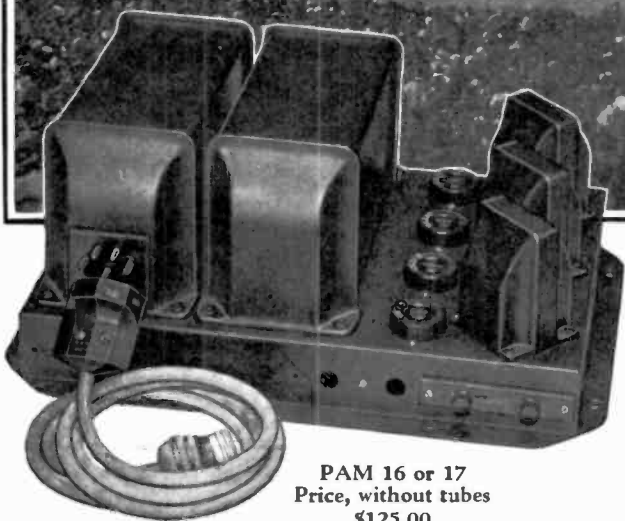

PAM 16 or 17
Price, without tubes
\$125.00

Bring the touch down into your home with a PAM Amplifier

BRING the game straight into your own home—all its thrilling moments; the cheers; the between-halves music. And all so clearly, so perfectly reproduced that never is there any sense of straining your ears to avoid missing something.

You can control the reception from a whisper to a "volume magnificent," from normal room volume to that which neighbors blocks away can easily understand. Or supply the game to a number of speakers or headphones in apartment houses, hospitals, hotels, etc.

The Samson PAM 16 is for ordinary and the

PAM 17 for dynamic type speakers for which it supplies field current. Both are built in accordance with AIEE Standards and Underwriters' Requirements. These amplifiers are completely AC operated and are designed to run from 105-120 volt, 50-60 cycle AC lighting circuits.

Send for handsome folder R2, describing the above and other Samson PAM Amplifiers which are also a "Sound Investment"

Main Office: Canton, Mass.
Manufacturers Since 1882

Samson Electric Co.
RMA

Factories at Canton
and Watertown, Mass.

Controls That Assure Satisfaction!



To the
Set Builder or Owner
To the
Eliminator Builder
To the
Set Manufacturer



**TRUVOLT
ALL-WIRE
Resistances**

U. S. Patent
1676869 and
Pats. Pending

Unique construction permits use of much larger resistance wire and keeps unit cool on the air-cooled engine principle. Gives accurate control of voltage, has far greater current-carrying capacity assuring long life.

In Truvolt Variable, the Contact arm slides smoothly over the turns of resistance wire, giving constant and delicate graduation of voltage through the complete range. An exclusive feature of Truvolt Fixed Resistances is that the contact taps can be moved and set at any point to afford fixed resistances of any values desired.

Twenty-two stock Types of Truvolts with resistances up to 50,000 ohms—all rated at 25 watts. A full line of fixed and tapped wire resistances.

YOU don't have to be a technical expert to know why you should choose **Electrad Resistances** for control of your eliminators or receiver. The "Electrad" name stands for the utmost quality, the most approved designs, superior accuracy and dependability in controls for all radio purposes. It is your assurance of fine performance and satisfaction.



Exclusively Licensed by Technidyne Corporation under U. S. Patent No. 1593658, 1034103, 1034104.

**Royalty Variable
High Resistances**

Widely popular with builders of receivers and power units, due to their unusual accuracy and efficiency. Also free from harmful inductance and capacity effects, because only a minimum of metal and the finest of insulating materials are used in their design.

Same resistance always secured at same point. Whole resistance covered in one turn of knob. There is a Royalty for every purpose—11 types in all, designated A to L. Potentiometer type in all sizes \$2.00. All other types \$1.50.

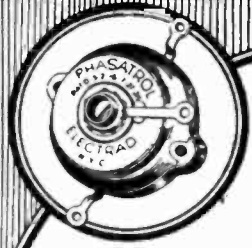

Licensed by Rider Radio Corporation.
Pat'd 5-2-16
Pat'd 7-27-26
Pats. Pending

PHASATROL

A True Balancing Device for Radio Frequency Amplifiers

Every fan who is building a set, or who now owns one, will want Phasatrol once he knows its efficiency in suppressing the squeals and noises of oscillation. Also checks distortion—clears up distance—and simplifies tuning. Very easy to install. Price \$2.75.

That is why prominent radio engineers and circuit designers recommend **Electrad Truvolts, Royalties, Phasatrols and Tonatrols** for many of the best known eliminators and receivers.



Exclusively Licensed by Technidyne Corporation under U. S. Patent No. 1593658, July 27, 1926

TONATROL

A True Tone and Volume Control

Volume through its complete range—from a mere whisper to full power—is at your finger tips with this superior control. An improvement for any receiver, and very simple to install. A full line of controls for battery and A. C. operated receivers. Prices \$1.50 to \$3.00.

Electrad Specializes in a Complete Line of Controls for all Radio Purposes, including Television.

Write for Free Installation Booklets and full information

Dept. H-12, 175 Varick Street
NEW YORK, N. Y.

ELECTRAD Inc.

Pacific Coast Office, 905 Mission Street, San Francisco, Calif.

RADIO

Radiatorial Comment

THE United States Supreme Court has decided that De Forest's regenerative patents are valid. This decision probably ends a controversy that has been bitterly waged for years. The feed-back circuit thus becomes the first of the controversial radio patents to be adjudicated by the court of last appeal.

Although Armstrong had the first regenerative patent, De Forest had discovered and applied this principle during his early experiments with the three-electrode vacuum tube, of which he was the inventor. After successfully fighting the interference claims of Armstrong, Langmuir, Meissner and Arnold in the patent office and lower courts, De Forest was finally granted patents on regeneration and oscillation in 1924, twelve years after the performance of his original experiments.

His patents do not cover all methods of producing regeneration. In receiving circuits, Armstrong still retains the right to use an inductance in the filament lead which is common to both the input and output circuits. For transmitting, Hartley has a patent on a circuit without a grid condenser. This patent is owned by the Radio Corporation of America, which, through transfer of rights, may also use the De Forest patents.

Consequently De Forest has finally won the right for his company and licensees to use regeneration, but he cannot restrain the R. C. A. from doing likewise. However, regeneration is not public property; non-licensed regenerative receivers and transmitters still infringe upon strongly-held patents. The De Forest patents have thirteen years to run, and the Armstrong patent expires in 1930.

* * *

ONE probable result of operation with the broadcast allocations which became effective on Armistice Day is a general recognition

of the need for new legislation to supplement the Davis-Dill amendment, under which the new wavelength and time assignments were made. With the present set-up, each zone is limited not only to the same number of wavelengths, which seems equitable, but also to the same number of stations simultaneously using each wavelength, which seems inequitable.

For instance, no more stations are allowed to serve the very large areas of the third and fifth zones than serve the small area of the first zone. The common denominator for all zones is the number of stations which can simultaneously operate without interference in the smallest zone. This deprives many localities of day and even night service from small stations that might otherwise operate without interfering with each other.

As this discrimination against the larger zones cannot be corrected under the present equalizing law, another amendment is necessary. However, it is unlikely that adequate consideration of the matter can be given during the short term of the present Congress. So its enactment will probably be delayed until the new Hoover administration assumes control.

* * *

RADIO television, in crude form, is now possible for the class of experimenter who is able to read and understand the kind of articles which are printed in a semi-technical radio magazine. Those who know enough to build their own receivers and who do not yet expect perfection of performance can see moving shadow-graphs if they are within the effective range of a station which is broadcasting television signals.

But this does not mean that the art has yet reached a stage where the general public can expect to see radio pictures in the home as they now hear radio programs. Nor is it any reason for postponing the purchase of a set for aural reception. When television "arrives," a sep-

arate piece of equipment will be necessary for its reception.

* * *

BROADCAST advertising employs electricity instead of paper as an effective medium for shortening the distance between seller and buyer. Thus, for some kinds of mass selling, the spoken word is gradually replacing the written word. The sales appeal is to the ear rather than through the eye of the buyer. Some people say that Smith's radio speeches were responsible for Hoover's victory.

* * *

CONSIDERABLE interest has been aroused in radio prospecting or the use of high frequency electric current for locating ore bodies. The general methods have frequently been described in these and other columns. But it has remained for J. J. Jakosky to present a complete technical discussion of the subject in the October, 1928 *Proceedings* of the Institute of Radio Engineers. His conclusion is that the results of any electrical geophysical survey, to be of value, must be interpreted by a trained staff of mining engineers and geologists. This work opens another new field for the man who is familiar with radio principles and equipment.

The mining profession was sceptical when these experiments were first made, regarding them as a modern revival of the ancient divining rod. But so many successful surveys have been conducted by this means that the work of competent operators now commands the respect that it deserves. A recent bulletin from the U. S. Bureau of Mines describes some of the practical methods which are employed.

* * *

READERS of technical radio literature who hereafter encounter the "Deci-Bell" or "DB" will be interested in knowing that this is the new name for the transmission unit or "TU," which is the engineer's yardstick for measuring the efficiency of an electrical communication circuit. Nearly all countries which use the radio or telephone have agreed to the adoption of this new term. DB is interchangeable for "TU" wherever the latter occurs in the older writings, the values being the same.

Obviously the change honors the name of Alexander Graham Bell, just as the names of Volta, Ampere and Watt are honored by the

ordinary electrical units for potential, current and power. Deci is a prefix signifying tenth.

The expression is mathematical and relates to the ratio of power, voltage or current conducted by electrical circuits. Thus, if one circuit transmits 10 times as many watts as another, there is a difference of 10 DB between them. If the power ratio is 100, the difference is 20 DB. If it is 1000, the difference is 30 DB. For 10,000 it is 40 DB, etc. It will be noted that the number of DB is 10 times the logarithm of the power ratio.

As voltage or current ratios and not power ratios are usually measured in radio circuits, and as power ratios are equal to the square of voltage or current ratios, the number of DB becomes 20 times the logarithm of the ratio of voltage or current. For example, a two-stage audio amplifier giving a voltage amplification of 400 has $20 \log 400 = 52$ DB.

This distinction between power and voltage ratio has frequently been overlooked in the preparation of curves showing the efficiencies of transformers and loud speakers at different audio frequencies. Amplification measurements are ordinarily made with a voltmeter. When the voltage readings are converted into DB units some workers have multiplied the logarithm by 10 instead of by 20, thus giving an erroneous curve.

One of the reasons for employing this apparently cumbersome notation is that it is true to nature. We hear logarithmically. The ear's response is proportional to the logarithm of the sound energy. A full orchestra playing at its loudest, sounds only sixty times as loud as when playing at its softest, although the amount of sound energy is a million times greater. ($10 \log 1,000,000 = 60$). This fortunate provision of nature protects us against injury from very loud noises.

The normal human ear is just able to detect a difference of one DB between the loudness of two notes. In the present state of the radio art an amplifier or loud speaker may be considered as passably good if it gives a differentiation of less than 10 DB between a high and a low note. This means that if the voltage amplification of a 100-cycle note, for example, is not less than about one-third that of a 1000-cycle note, the equipment will give fairly satisfactory reproduction of music. ($20 \log 3 = 9.54$ DB).

WLW'S 50,000-Watt Transmitter

NATION-WIDE reception of WLW's new 50,000-watt transmitter at Mason, Ohio has aroused interest in the equipment whereby this was made possible, especially as it contains several innovations in the standard Western Electric apparatus. These changes include 100 per cent modulation of the carrier instead of the customary fractional modu-

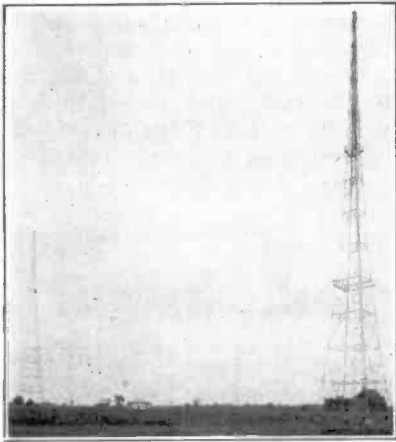

300 Ft. Towers at WLW

lation, a harmonic filter, and an especially effective antenna ground system.

The 300-ft. steel towers are spaced 600 ft. apart on a north and south line, 400 ft. west of the transmitter. Under the center of the antenna is located the coupling house which is shielded from the intense field by means of a copper roof. Within this house is the junction of four heavy diagonal ground busses to which are soldered 30 miles of ground wire buried 10 in. deep in furrows 2 ft. apart. From this house also runs the insulated transmission line which carries the modulated high-frequency electric current from the transmitter.

The transmitter is installed in a two-story brick, concrete and steel building, the transmitter itself and the control room being on the main floor, and a duplicate set of motor-generators, recti-

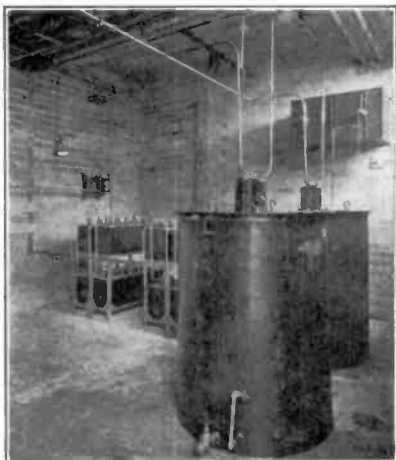

High Voltage Filter System

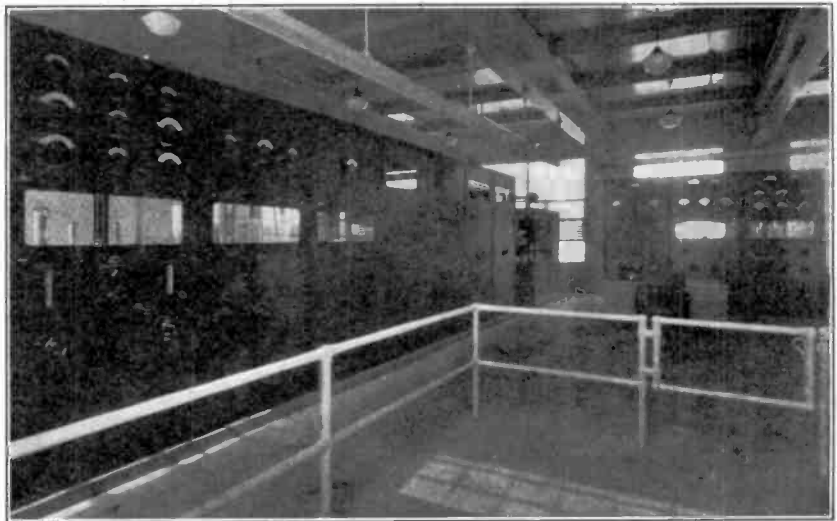

Control Room at WLW

fier transformers, fans and pumps in the basement. In the basement also is the high-voltage filter system, whereby har-

monics are eliminated before the energy is radiated. Constancy of frequency is
(Continued on Page 44)

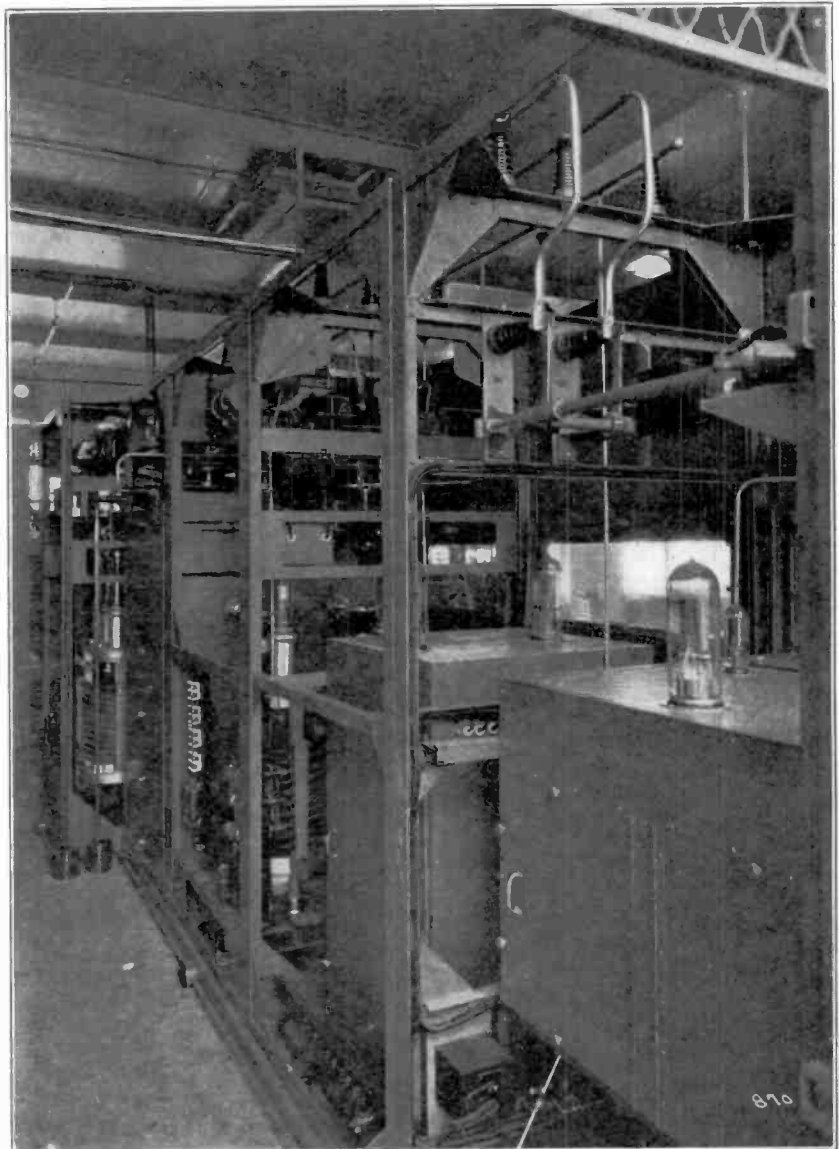

Amplifier and Modulating Unit

High Frequency Electric Furnaces

Methods and Equipment Used for Melting Alloys for Dental Use

By PAUL W. HERMANN

A REAL field of application for the high frequency induction furnace has been found in the melting of precious metals and their alloys for dental use. Although this has been picturesquely advertised as "melting by radio" it is merely another industrial application of the high frequency current which is also used for radio transmission. The output of a high frequency generator is connected directly to an induction coil whose electromagnetic field is intercepted by the material to be melted, this being placed within the coil. The eddy currents thus produced are effective in heating the material to very high temperatures.

This conversion of electric power into heat is accomplished by using a relatively weak magnetic field and a relatively high frequency. The typical furnace installations illustrated in Fig. 1 utilize the

2000 kilocycle output of a mercury discharge-gap oscillator which delivers about 5 amperes at from 6000 to 8000 volts.

Figs. 2 and 3 show the construction of a furnace unit. It consists essentially of a cylindrical chamber surrounded by a coiled conductor, which is insulated from it both thermally and electrically.

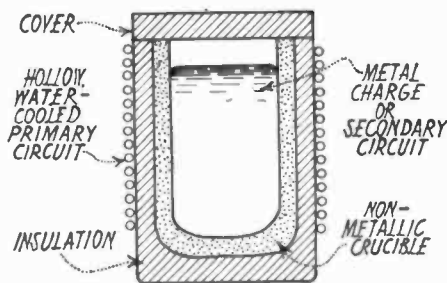

Fig. 3. Cross-Sectional View of Induction Furnace

The thicker the insulation, the less is the electromagnetic energy which enters the chambers, since a smaller part of the field cuts the resistor. The thinner the thermal insulation, the greater is the amount of the heat energy radiated outward from the crucible and lost. The primary is a coil of copper tubing through which water is circulated so as to keep it cool. The secondary is the metal to be melted. Glass or other non-conductor cannot be melted in this type of furnace unless it is placed in a crucible

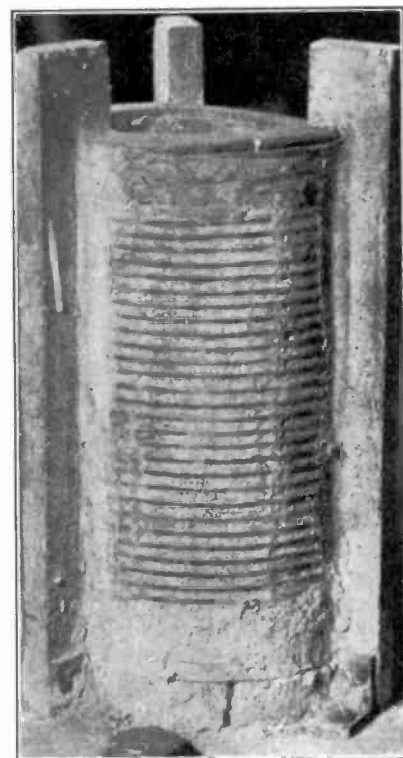

Fig. 2. View Showing Furnace Construction

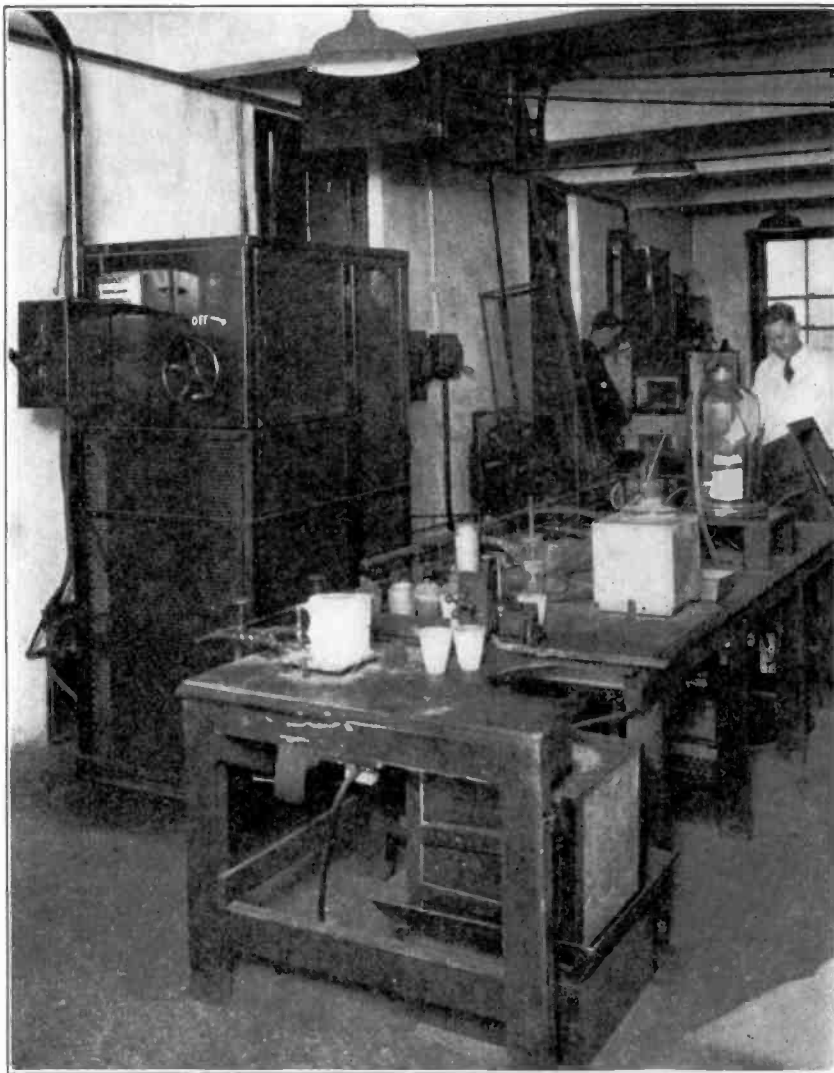

Fig. 1. Typical Installation of Small High Frequency Furnaces

which is itself a conductor, such as graphite.

Temperatures attained are in excess of 5000 degrees F., as compared with less than 3000 degrees F. in a standard gas or oil furnace. This is sufficient to melt platinum in so short a time that a strip of metal may be held in the hand, as in Fig. 4 and melted within an inch or so of the fingers without any discomfort. The electromagnetism, and thus the heat, is concentrated toward the center of the crucible so that surrounding objects are not heated.

The operator has easy control of the temperature by varying the magnetizing current so that the charge is not superheated. Furthermore the eddy currents in the molten metal set up a vigorous stirring action which brings about the

complete mixture necessary to form a true alloy. All previous methods of mechanical stirring would allow platinum, with its specific gravity of 21, to segregate from gold or copper in the billet, thus giving undesirable characteristics for dental work.

The furnace can be operated in a vacuum, as in Fig. 5, or in a highly reducing atmosphere so as to prevent oxi-



Fig. 4. Melting Platinum in High Frequency Furnace

the Ajax Electrothermic Corporation. They have recently perfected a small furnace, which is supplied with high frequency current from a 250-watt vacuum tube converter.

Most of the industrial installations, however, use either mercury discharge-gap oscillators or high frequency generators of the non-inductive type. Relatively lower frequencies are used with

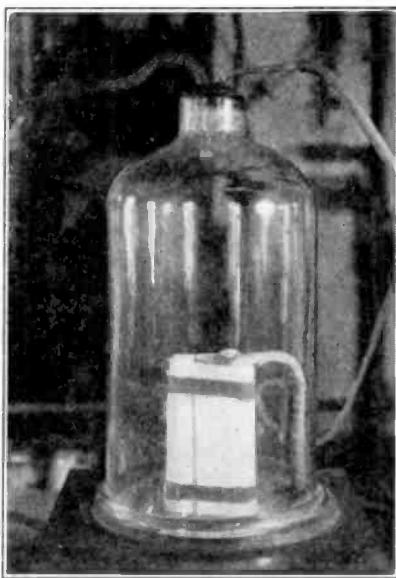

Fig. 5. Furnace Operated in Vacuum

dation. This eliminates the necessity for fluxes and their consequent inclusions.

One high frequency induction furnace will melt more high-fusing metal in half an hour than can be handled by a gas furnace in a full day. With 16 kw. input 30 ounces of platinum can be melted in two minutes. There are no fumes, smoke or gases, and no heat radiation from the furnace, so that the operator works in comfort. The former foundry becomes an immaculate laboratory.

Much of the development work for this type of furnace, which was originally invented by Dr. E. F. Northrup, has been accomplished by the Williams Gold Refining Company in co-operation with the General Electric Company and

the latter, 960 cycles being common. Large furnaces are in service for melting silver in 900-pound charges and copper alloys in 700-pound charges. Units of 250-pound capacity have been successfully used for melting nickel and pure iron for the production of per-malloy.

Fig. 6 shows the circuit diagram for a mercury discharge-gap oscillator and furnace. In this type of equipment power is delivered from the oscillator at from 5 to 100 k.c. The frequency is increased as the size of the coil or the number of condensers is reduced, smaller furnaces requiring higher frequencies. The same amount of heat may be created with a field of unit strength and a frequency of 60 k.c. as with a field 1000

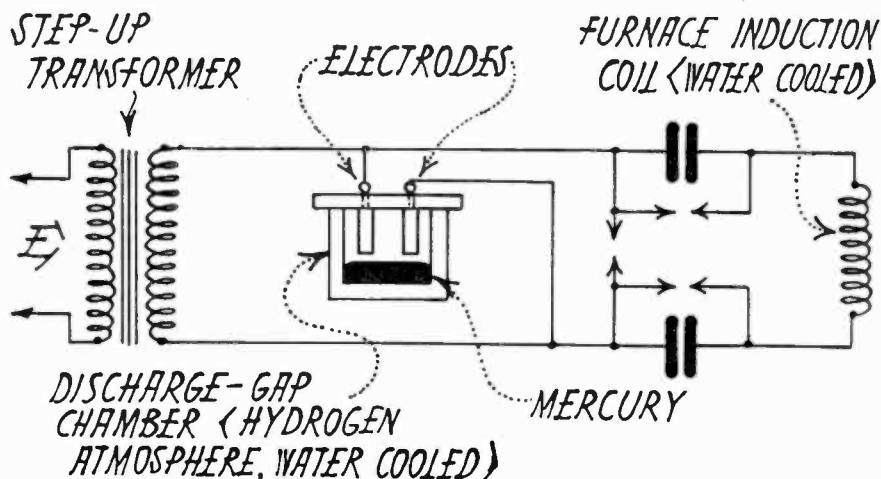

Fig. 6. Circuit Diagram of Mercury Discharge-Gap Oscillator and Furnace

times as strong and a frequency of but 60 cycles per second.

The Bureau of Metal Research at the Carnegie Institute of Technology has recently applied the high frequency furnace to the refining of manganese. The metal is placed in a magnesia crucible which is covered by another inverted crucible to collect the distilled metal. These crucibles are placed inside a fused quartz tube, 4 in. in diameter and 2 ft. long, closed at both ends. The quartz tube is surrounded with a water-cooled copper coil through which 2 amperes of high frequency current is inductively passed at 7700 volts. This produces the pure metal which is necessary in some steel alloys. Many other industrial applications of the high frequency furnace are in process of development.

BROADCASTING IN PARIS

By R. RAVEN-HART

PROGRAMS—often magnificent. Transmissions—almost invariably bad. And bad to a degree that an American listener would hardly credit. It is no exaggeration to say that neither of the two "official" stations (the Eiffel Tower and the "PTT," otherwise the Higher School of the Post, Telegraph and Telephone Department) would have been tolerated in America ten years ago, and at the present day they can only be regarded as rather tedious jokes, not in the best of taste.

Unfortunately, some of the best programs come from them; above all, the Saturday and Sunday concerts of the Padeloup orchestra. It is hard to imagine anything more exasperating than to see pieces on the programs which one would love to hear, and to tune in, with the hope that possibly some miracle may have occurred, and then. . . .

Were it not for the private stations, it would be difficult to believe that any radio sets are sold; more especially Radio Paris (run by the largest radio company), the "Petit Parisien" (run by the newspaper of that name), Vitus, and L. L. (run by smaller manufacturers). All these four have decent modulation, and the first named can be relied on for passable programs with occasional gems. The second does not transmit daily, and its programs are as a rule rather hackneyed. The two last are low-powered and rather masked by buildings—they are as a result none too easy to pick up, even within commuting distance of Paris. This is a pity, as their programs are of a varied nature, often quite exceptional; in the case of "Radio Vitus" whose subtitle is the "Montmartre Radio"; one sometimes begins to wonder whether the mike is not getting overheated, or some of the plates of the tubes blushing!

According to the strict letter of the law, radio is a government monopoly.

(Continued on Page 38)

A Short-Wave Superheterodyne

By R. WILLIAM TANNER

THE most sensitive and selective set for receiving telephone or telegraph signals, whether long or short wave, in the author's experience, is the superheterodyne. Furthermore only four plug-in coils are required to completely cover the spectrum from 20 to 200 meters, with a .00015 mfd. condenser.

As may be seen in the circuit diagram (Fig. 1) this is a five-tube set, comprising a first detector, oscillator,

two intermediate frequency stages, and second detector. The set is designed to use '99 type of tubes throughout, though slightly greater signal strength may be had with '01-A tubes in the i.f. and second detector sockets.

The first essential for selectivity is low resistance in the first detector cir-

cuit. This may be secured by space winding the coils, L in the circuit diagram, with No. 28 enamel wire on old UX tube bases. The primaries are $\frac{3}{4}$ -in. diameter and 1 in. long and are placed inside the bases. The secondaries are wound outside the bases and are 1 in. in length. The leads are soldered to the

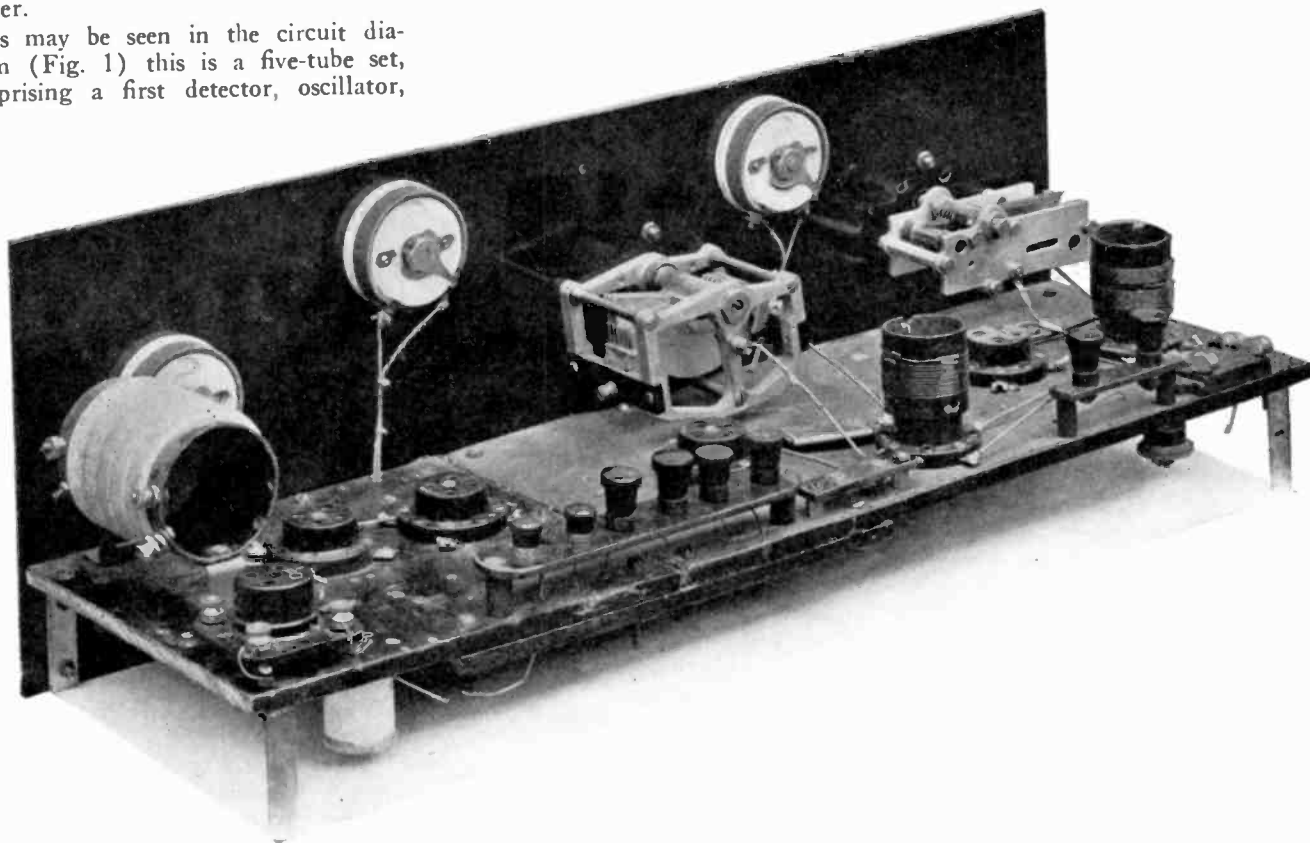

Rear View of Short-Wave Superheterodyne

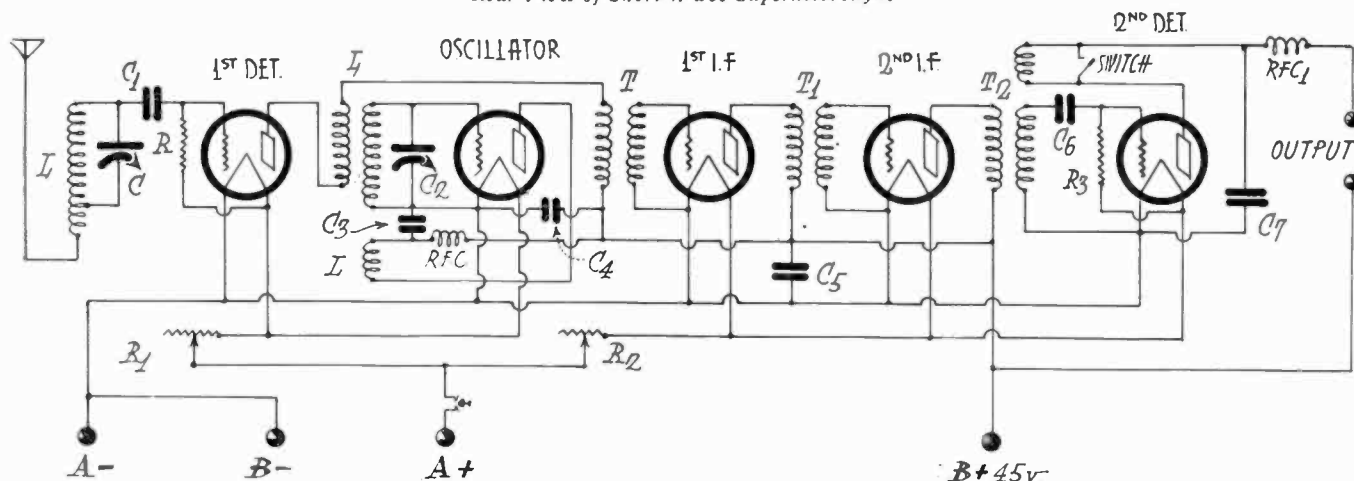

Fig. 1. Circuit Diagram of Short-Wave Superheterodyne

- L—See text.
- C—0.00015 mfd. detector tuning condenser.
- C₁—0.00025 mfd. detector grid condenser.
- C₂—0.00015 mfd. oscillator tuning condenser.
- C₃—0.0025 mfd. oscillator bypass condenser.
- C₄, C₅—1 mfd. bypass condenser.
- C₆—0.0005 mfd. second detector grid condenser.
- C₇—0.002 mfd. second detector bypass condenser.

- R—5 to 10 megohm grid leaks.
- R₁, R₂—30-ohm rheostats.
- R₃—2-megohm grid leak.
- T₁, T₂—See text.
- RFC—200 turns No. 36 enamel wound on a thread spool $\frac{3}{4}$ in. diameter in 25 turn sections, $\frac{1}{16}$ in. between sections.

- RFC₁—See text.
- SW—Tickler switch.
- SW₁—Filament switch.
- 7 UX sockets.
- 5 UX 199 tubes.
- 2 binding post strips.
- 7 in. x 21 in. panel.
- 7 in. x 20 in. baseboard.
- 2 panel brackets.

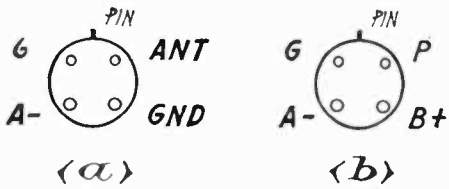

Fig. 2. Lead Connections for First Detector and Oscillator Coils.

prongs as shown in Fig. 2 (a). The number of turns for the different coils are as follows:

	20 meters	40 meters	80 meters	160 meters
Primary	3 turns	6 turns	10 turns	10 turns
Secondary	7 turns	14 turns	29 turns	60 turns

A tuning condenser capacity of .00015 mfd. is secured by removing all but three of the rotary plates of a .0005 mfd. condenser, or any good low-loss condenser of equivalent capacity may be used.

The grid leak should be from 5 to 10 megohms; the grid condenser from .0001 to .00025 mfd., the lower value being better for 20 meters. An extra control for regeneration does not seem to be justified for the slight increase which it gives in sensitivity.

The oscillator is of the series feed type. The tuning condenser is connected across the grid coil only and not from the grid to the plate as is usually done in broadcast supers. The rotor is then at ground potential, thereby eliminating hand capacity effects. A by-pass condenser of .0025 mfd. is shunted across the plate supply. The r.f. choke prevents the r.f. currents from getting into the B battery. The energy is fed to the first detector by coupling a loop brought out from the plate circuit of the detector to the oscillator coil. This loop consists of 10 turns of No. 28 enamel wire wound around the oscillator coil socket. The oscillator coils are wound on UX

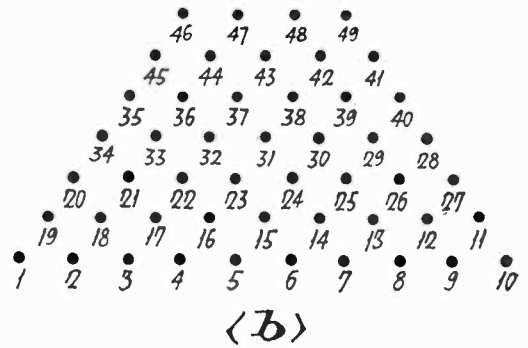
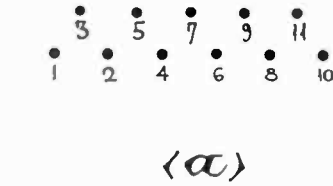

Fig. 3. Bank Winding Details

tube bases with the same size wire as is used on the detector coils.

	20 meters	40 meters	80 meters	160 meters
Grid	8 turns	16 turns	33 turns	65 turns
Plate	8 turns	16 turns	33 turns	65 turns

The 160-meter coil will have to be two bank wound in two equal sections as the tube base is not long enough to accommodate a total of 130 turns. D. C. C. wire is used in this case as it is superior to enamel for bank windings. Not only is it easier to work but the distributed capacity is much lower. In bank winding coils two turns are wound on tightly, then one turn is wound on top of these. Next bring the wire back down to the tube and wind on another turn, then wind the next turn on top of this and so on. At the cross overs bend the wire sharply with the thumb nail. Those who have had no experience with this type of winding had better practice with some old wire before attempting to make a permanent coil. It is very easy after a little experience. See Fig. 3 (a).

The grid parts of the coils are wound near the bottom and the plate section at the top. Grid and plate connections are made to the outside ends. The inside ends go to the A negative and the B

positive. See Fig. 2 (b). Tuning is done with a .00015 mfd. condenser of the straight line frequency type.

The intermediate frequency amplifier is the heart of the super. This one gives a large gain per stage with a minimum of noise, and can be sharply tuned without cutting off the side bands. The frequency is 160 kilocycles, or about 1800 meters. Two stages proved to be sufficient.

This required three transformers which are of different construction than those usually employed. The secondaries are group bank wound of 476 turns of No. 28 D. C. C. wire on bakelite tubes 2 in. in diameter and 3 in. long. The method of winding is shown in Fig. 3 (b) except that there are 20 turns on the bottom layer. Four groups of 119 turns are required for each secondary. Wind

(Continued on Page 39)

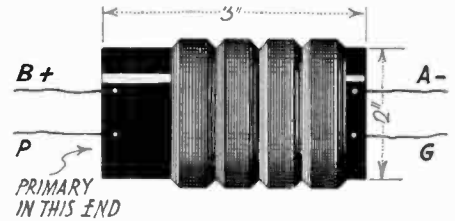

Fig. 4. I. F. Transformer Details

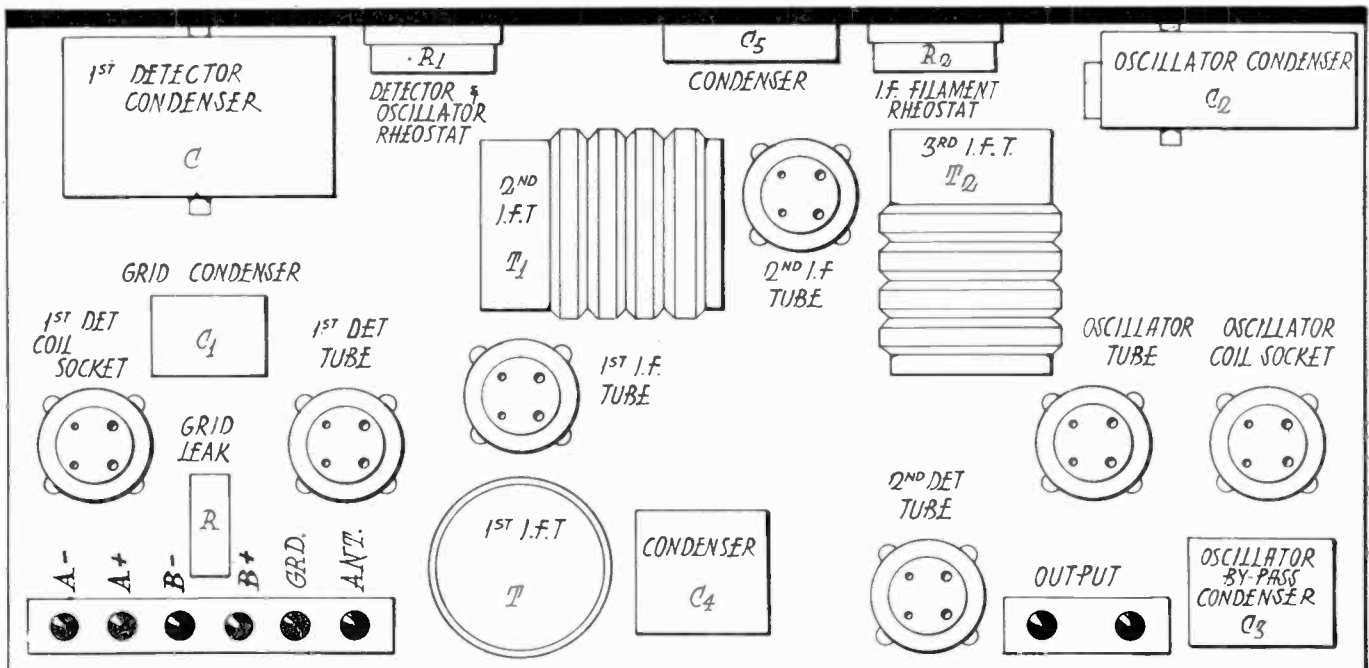

Fig. 5. Layout of Parts for Short-Wave Super

Experimenting With the Grid Leak

By L. W. HATRY

OLDER textbooks tell us that the function of the grid leak is to dribble away electrical energy with which the grid condenser brims. Later wisdom presents a theory, easier both to believe and to understand, which views the resistance as the essential element. Stuart Ballentine says, "So far as the process of detection is concerned, the grid condenser is not only superfluous but harmful as a potential source of frequency distortion."

The condenser by-passes all alternating currents in the circuit, offering greater impedance at the lower frequencies. This means that the detector seriously favors the treble at the expense of the bass; a fact that has been substantially proven by experiment. The realization of this fact has led, of course, to the desire to substitute a better device for the resistor and condenser, some other type of impedance that would be less discriminating in its choice of frequencies.

The secondary of certain good a.f. transformers would do the trick very

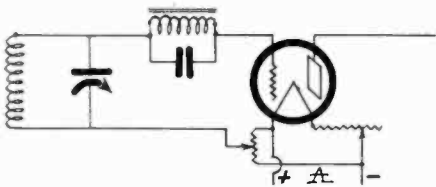

Fig. 1. Replacement of Grid Condenser by A. F. Choke

nicely, as shown in Fig. 1, except for the fact that with the primary hanging free, there is entirely too much stray capacity to various nearby wires. Moreover, as the grid voltage is 5 volts positive instead of (in the case of the 201-A tube), about .2 volts positive, a potentiometer is necessary to allow variation of the grid voltage between 1 volt negative and 5 volts positive, so that the tube has a chance to perform at its most effective grid potential.

But Fig. 1 is by no means the circuit

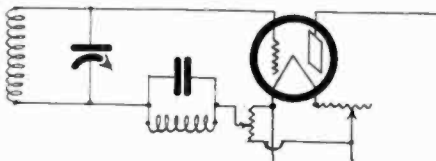

Fig. 2. Another Method of Using A. F. Choke as a Grid Impedance

to be recommended. Fig. 2 shows another method of using the choke. But after trying every available iron core inductance I finally decided that I should continue to use the old-fashioned grid leak and condenser, except in a superheterodyne.

In the first detector of a superheterodyne the use of the grid leak and condenser is attended with great difficulties, because detection ordinarily takes place by plate circuit rectification instead of the usual grid rectification. Facing the inadequacy of the grid leak-condenser combination as a higher frequency impedance we discover upon calculation that at 100 k.c., detection is only 4% efficient. (See Stuart Ballentine, Proc. I. R. E., May, 1928). In substituting another form of impedance in the first detector grid circuit we find that, as we are not dealing with audio frequency, an iron core choke is not to be considered, unless it is desired to add the effects of resistance. What we must do then is to devise a tuned r.f. circuit.

To quote Ballentine: "I investigated several years ago, the scheme shown in Fig. 9 (Fig. 3 of this article). Here the circuit LC, anti-resonant at the intermediate frequency, is placed in series with the grid and replaces the grid condenser and leak. The efficiency of detec-

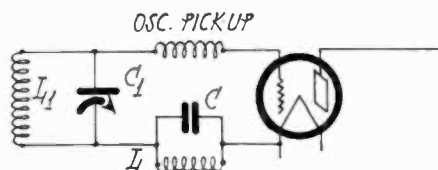

Fig. 3. Theoretical Use of A. F. Choke with First Detector of a Superheterodyne

tion in the grid-circuit is thus increased from 4 to about 50%."

As Ballentine says, LC causes the detector to become a tuned-plate-tuned grid regenerative rig at the intermediate frequency. Fig. 3 is both incomplete and impractical (it was intended only for a theoretical illustration) because the wrong grid-bias is inevitable and because the two-terminal loop L_1 is seldom used. When it is used the rotor plates of the

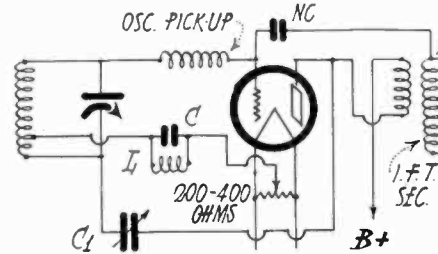

Fig. 4. Practical Circuit for Three-Terminal Loop

tuning condenser C_1 should be at ground potential and connected to F positive or negative.

The practical circuit for the three-terminal loop takes the form of Fig. 4. LC is tuned to the intermediate frequency. C_1 is the usual regeneration

control midget of .00005 mfd. maximum. The special 200 or 400-ohm potentiometer controls detection effectiveness and will prove a better volume control than the usual intermediate potentiometer which can be set and forgotten. NC is a very small capacity made of a couple of metal angles which can be moved apart; it is a neutralizing con-

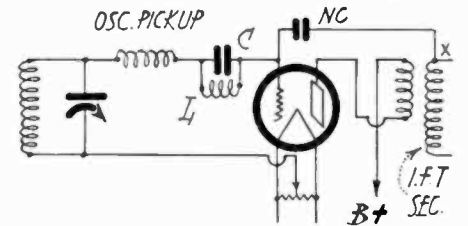

Fig. 5. Practical Circuit for Two-Terminal Loop

denser to prevent the first detector from oscillating at the intermediate frequency. If it does not work reverse the connections from the detector to the primary of the first I. F. T. The best neutralizing method would be made possible by the use of a center tap in the primary of the I. F. T.—which, of course, would have to be specially made.

The practical circuit for the two-terminal loop is shown in Fig. 5. LC's sharpness is reduced by the normal input resistance of the detector. As there is no important reason why the oscillator pick-up should be in series with the grid lead, it may be placed in the F return, the wire to the potentiometer center arm.

Either Figure 4 or 5 is a working circuit. Both are superior to detection with a C battery which in turn is superior to detection with the grid leak and condenser. I am not sure whether the tuned grid-impedance is superior solely because of its effect upon rectification or largely because of the I. F. regeneration it puts into the detector circuits. Used with the shield-grid tube at a frequency of about 400 kc. ("one-spot" tuning) the difference between the grid-impedance and the C battery was marked.

In both Fig. 4 and Fig. 5 NC is fixed only if the voltage at X is not artificially attenuated, as, for instance, by change of the I. F. A. potentiometer. Consequently the I. F. A. potentiometer should be set near maximum and kept there while volume is controlled with the detector biasing potentiometer. As mentioned, however, the better circuit demands a center-tapped primary on the detector-coupling I. F. T.; then the setting of the detector potentiometer may remain at optimum adjustment which allows maximum loop selectivity and eliminates upset of carrier frequency regeneration.

Radio Picture Transmission and Reception

Photoelectric Equipment and Methods for Visual Communication

By JOHN P. ARNOLD, *Departmental Editor*

TELEVISION RECEPTION METHODS

THE first consideration that governs the construction of a television receiving outfit is the character of transmissions which are available for reception. Whether they are on long or short wavelengths will not only determine the type of radio receiver, but also, usually, the size of scanning disc. The 24-line pictures are ordinarily transmitted on the regular broadcast wavelengths and the 48-line pictures in the short-wave carriers.

Reception of a 24-line picture requires a receiver that will tune, detect and amplify a 5000-cycle frequency band without favoring any particular part of it. This is ordinarily possible only when resistance or impedance coupling is used in the amplifier, as transformer coupling does not yet give the uniform frequency amplification, which is essential to good quality of television images.

For the 48-line picture the same type of audio amplifier is necessary for as high as a 20,000 cycle band. The tuner may be either a regular short-wave regenerative outfit or an r.f. stage may be used. Plate detection gives better quality than grid detection, although the signal strength is less.

The first requisite is that the television signal, as picked up by the antenna, is of sufficient strength. Otherwise poor results will be obtained. As in aural reception, very weak television signals

TELEVISION STATIONS

Station	Location	Wave-length	Disc Holes	Pictures per second	Tentative Schedule
WGY	Schenectady, N. Y.	379.5	24	21	12.30-1.00 p. m., Tu., Th., Fri.
2XAF	Schenectady, N. Y.	31.4	24	21	10.30-11.00 a. m., Tu.
2XAD	Schenectady, N. Y.	21.96	24	21	9.15-9.30 a. m., Sun.
WRNY	New York City	325.9	48	10	First 5 min. of each hour
2XAL	New York City	30.91	48	7.5	First 5 min. of each hour
3XK	Washington, D. C.	46.72	48	15	9.00 p. m., Mon., Wed., Fri.
WCFL	Chicago, Ill.	61.5	45	15	Irregular
WKBI	Chicago, Ill.	215.7	48	15	Have applied for license
WIBO	Chicago, Ill.	305.9	45	15	1.00 a. m., Mon., Wed., Fri.; 1.30 a. m., Thur., Sat.
KGfJ	Los Angeles, Calif.	212.6	48	—	1.00-6.00 a. m.
WLEX	Lexington, Mass.	62.5	48	—	Building new apparatus

Note—No. of pictures per second, multiplied by 60, equals r.p.m. of motor. No. of holes in scanning disc is same as No. of lines scanned per picture.

greatly amplified with a lot of interference of equal or greater signal strength are unsatisfactory.

For 24-line pictures the scanning disc can conveniently be made 12 in. in diameter. Allowing $\frac{1}{2}$ in. from outer hole of spiral to edge of disc, will give a picture a little less than $\frac{1}{2}$ in. wide at its top. For a 48-line picture the disc is usually 24 in. in diameter and the picture again will be $1\frac{1}{2}$ in. in width. The disc should be centered properly, the holes drilled accurately, and the size of the hole about 10 per cent larger than calculated so that the paths will overlap. The discs should be perfectly flat and have sufficient strength. The weight should be kept at a minimum so that the

size of motor required will not be unduly large.

The motor should have sufficient power to rotate the disc at the various speeds required, but not much more. It should be of the variable speed type. A universal motor of about 1/15 h.p. and 1800 r.p.m. may be used with a light 48-hole disc. With a rheostat of a suitable resistance and current-carrying capacity the speed can be varied within that required for television reception, and manual synchronization maintained.

The most important part of the television unit is the neon lamp, the light of which varies directly with the current that operates it. It requires from 50 to 90 m.a. modulated output from a 210-

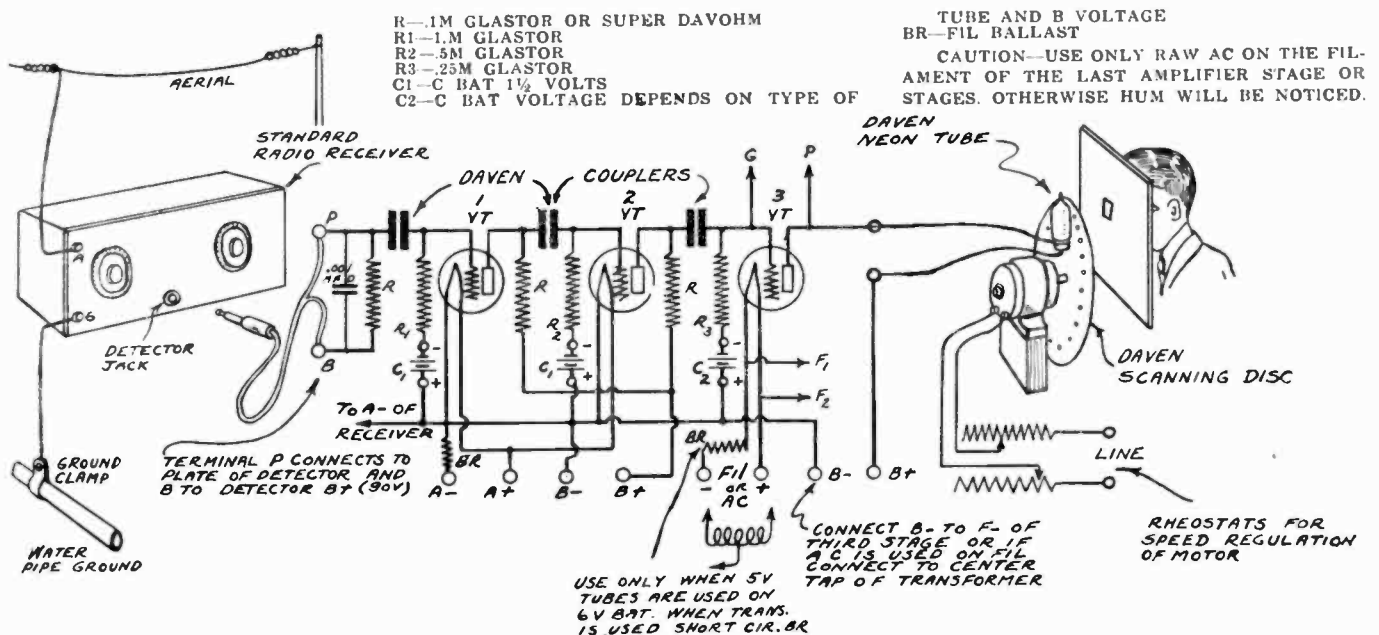

Circuit Diagram of Daven Television Amplifier

power tube to give sufficient illumination for a 48-line picture $1\frac{1}{2}$ in. square.

Little difficulty will be experienced in assembling the parts. Although an elaborate set-up as shown in the picture may be desirable, it is not absolutely necessary. For instance, a large piece of black cloth will prevent the diffusion of the neon lamp glow in various directions as well as the large cabinet, although the latter will keep the observer away from the revolving scanning disc and avoid any damage which may occur by the hand or other objects coming in contact with it.

The Jenkins Radiovisor

By C. FRANCIS JENKINS

IN TELEVISION (wire carried vision) and radiovision (radio carried vision) the picture scanning device consists of a disc with a spiral arrangement of holes therein, the disc making one revolution for each picture. The picture can only be as wide as the narrowest separation between two adjacent holes in the spiral, and only as high as the offset of the ends of the spiral.

As the minute apertures in the disc pass light so inefficiently, I made the apertures large, put lenses over each, and secured the required scanning spot by focusing the light source as an image point on the picture screen (U. S. Patent 1,679,086). This lens-disc was used in a public demonstration of radiovision and radiomovies in June, 1925, broadcast from Navy Station, NOF, Anacostia, and received in my laboratory in Washington, in the presence of many government officials.

But the disc scanner, whether apertured disc or lens-disc, has physical limitations in practical application, which seem, as at present employed, not to permit very much development.

The drum method is much more promising, for a cylinder, or drum, has none of the limitations of the disc, and has some meritorious features.

To get a mental picture of it (Fig. 1) structurally, imagine a hollow cylinder, fitted with a hub, hollow for the length of the drum. The hub has an extension

pipe. That is, the use of quartz rods avoids the light loss due to the inverse square law.

The cathode targets are located one each under each of the rows of quartz rods, and are lighted in succession through a 4-segment commutator, by current from the plate of the last tube of the radio receiver-amplifier. Because the movement of the inner ends of the rods is so short, these cathode targets need be only very small. These miniature targets obviously require only a small amount of current compared with the current required for a disc-scanned picture.

A multiple-spot lamp and drum apertures in a multiple-turn helix permits a small scanning mechanism, and a brighter and larger picture for a given radio energy. A 7-in. diameter drum Radiovisor with scanning apertures in four helical turns gives a picture which appears, magnified, to be about 6-in. square. Five or six people can conveniently enjoy the story told in the moving picture it produces. A 7-in. drum with six helical turns of scanning apertures gives a 3-in. picture, unmagnified; which is more than twice the area of any picture possible with a 36-in. scanning disc.

The transmitting equipment can be attached to any broadcast station apparatus. The drum scanner permits the

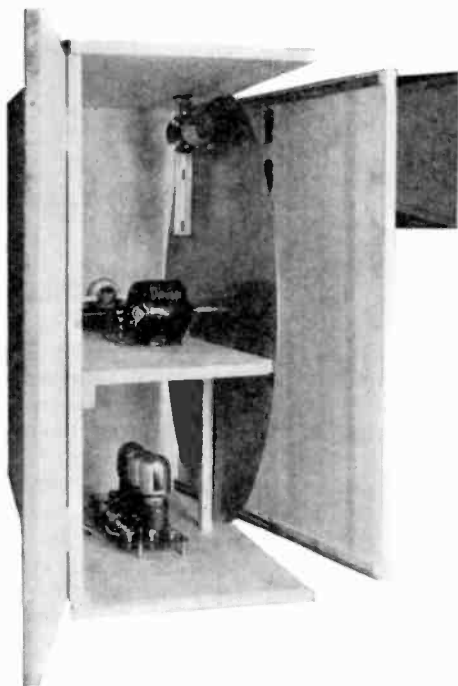

Complete Set-Up of Daven Television Receiver

The circuit diagram needs no further explanation. The radio set and the resistance-coupled amplifier have no unusual features which have not been found in ordinary radio construction. The motor and scanning disc should be placed at some distance from the set and amplifier. Use shock-absorbing supports so that motor disturbances and mechanical vibrations will not affect the amplifier tubes. Such effects often become visible as a permanent distortion of the images and thus can be distinguished from such transients as atmospheric, phase distortion and other communication channel disturbances.

Just one word to the uninformed constructor: do not expect too much in the way of quality. No one seriously contends that television is now any more than an experiment; but the more investigators who undertake to solve its problems, the sooner we can expect better results. Therefore if you like to experiment, go to it; even the present-day results in television reception are interesting although imperfect.

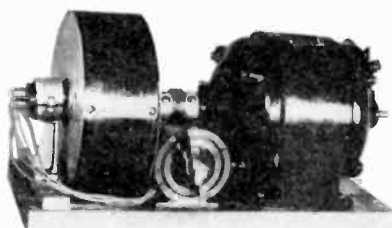

Fig. 1. Mechanism of the Jenkins Radiovisor.

outside the drum which slips on the shaft of a small motor. The scanning apertures are punched or drilled in the peripheral wall of the drum, each aperture of elementary area. The apertures are arranged in four helical turns.

Inside the drum-hub, a 4-target cathode-glow neon lamp, is held, by a clamp mounted on the motor platform, at the open end of the drum, preferably. Between the lamp and the periphery of the drum are tiny quartz rods, each rod ending under its particular minute aperture in the drum surface. A quartz rod has the peculiar property that light flows through it like water flows through a

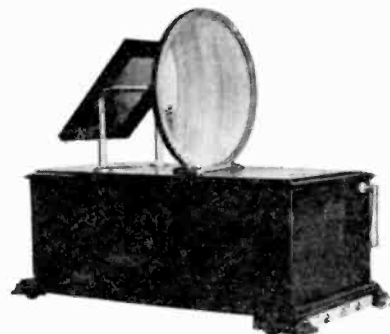

Fig. 2. Radiovisor for 6 by 6-in. Pictures.

construction of an inexpensive, practical-sized receiver (Fig. 2) for movie entertainment in the home.

Editor's Note: In this article Mr. Jenkins discusses the disc and drum methods of scanning, pointing out that the latter is a step toward more compact apparatus for television. Another feature of this system is the use of a four-target neon lamp which is required for this scanning method. He employs a moving picture film of the subject to be transmitted and this is received as a moving silhouette. This is the logical starting-point toward solving the more difficult problem of presenting extended views of natural scenes in graduated tones. The practical result of Mr. Jenkins' work has been to induce the radio amateur to experiment with the reception of images.

How to Overcome Volume Control Difficulties

A Discussion of Their Nature and of Methods for Solving Them in
A.C. Receivers

By FRANK C. JONES

An a.c. receiver offers many difficulties in securing an effective control of volume without affecting the quality or tuning of the set. Control in the audio amplifier, without provision to prevent the detector tube from being overloaded, introduces distortion. Detuning the r.f. amplifier of a selective set decreases the strength of the low frequencies adjacent to the carrier frequency and thus causes an over-emphasis of the high and intermediate frequencies. Varying the filament current with a rheostat soon introduces noise due to corrosion or dirt and is too slow on account of the delayed response of the heavy filament to changes in current.

The use of a variable high resistance in series with the *B* supply is effective in controlling the volume, but varies the plate voltage on all other tubes if a *B* eliminator is used. It also becomes noisy because of the d.c. flow to the variable resistance slider or arm. By keeping the plate current out of the variable resistance it is more likely to remain quiet.

There are several ways of controlling the volume quietly in or ahead of the r.f. stage. Many set builders use the method of antenna volume control

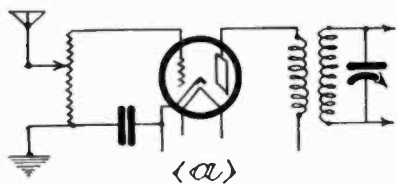

Fig. 1. Antenna Volume Controls

shown in Fig. 1 (a). For receivers having little r.f. amplification this is quite satisfactory. In some receivers an r.f. choke is shunted from aerial to ground so as to pass only the broadcast band through to the r.f. amplifier. But unless the receiver is doubly shielded the pick-up from the other stages of r.f. is great enough so that local stations will roar in on the minimum setting for volume.

Fig. 1 (b) shows a better type of antenna volume control having a tuned input from the antenna to the tube, being in effect equivalent to an additional r.f. stage. However, it has the common fault of not providing any control of volume on local stations if three or four stages of r.f. amplification are used.

Several plate circuit control systems are shown in Fig. 2. The method of Fig. 2 (a) generally gives slightly better control than the arrangement of Fig. 1, because it not only shunts the signal to

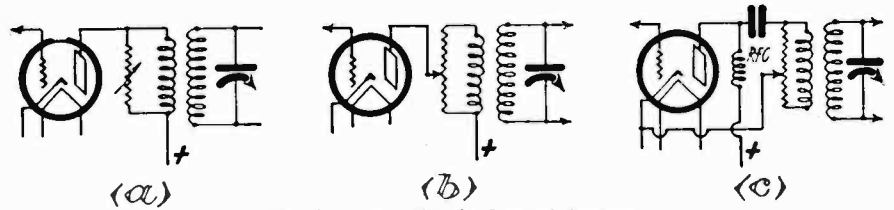
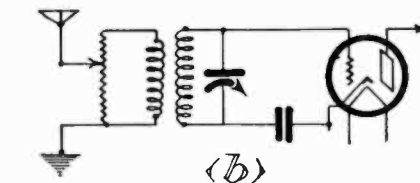

Fig. 2. Plate Circuit Control Systems

ground, but also drops the amplification of that stage due to the low plate load impedance. Most of the plate current will go through the r.f. coil primary and not through the resistor because of the former's lower d.c. resistance. This means a fairly quiet volume control and if the variable resistance is constructed so that its resistance varies not directly as the setting but as the square or even cube, then a fairly even control of sound will result. This scheme looks fine but, when the resistance is fairly low, it practically puts a short across the r.f. transformer primary, which in turn lowers the effective inductance of the secondary winding. This means that the tuning will change with volume control setting so that the circuits will not stay lined up for single tuning control. The receiver will tune broadly at one end of the broadcast band or the other, depend-



ing upon which end has been lined up properly.

Fig. 2 (b) gets away from the latter effect but causes a variation of d.c. plate potential with the troubles mentioned at the beginning of the discussion. Fig. 2 (c) removes this fault but costs more, since there is an additional r.f. choke and by-pass condenser. However, this arrangement is far better than any covered so far for receivers having not more than two or three stages of r.f. amplification. For receivers having three or more stages of efficient r.f. amplification, a single control will

hardly suffice for local reception. More will be said on that later.

The grid control method shown in Fig. 3 requires at least $\frac{1}{2}$ megohm resistance, while in the previous schemes a maximum value from 5,000 to 25,000 ohms was correct. Fig. 3 (a) gives a scheme which controls the volume very nicely on a receiver using as many as three stages of r.f., with four tuned circuits. It has the bad effect of changing the tuning because of the tube input capacity. At maximum volume setting this capacity is in shunt to the tuning condenser, so this arrangement is not very desirable. If the tuned circuits are lined up for maximum distance reception, the volume will cut off very suddenly as the grid slider is moved down the variable resistance because this circuit is thrown out of line.

Fig. 3 (b) gets around this trouble since the tube input capacity is always across the tuned circuit. However, the same tuned circuit has now a variable resistance across it which ruins the selectivity at lower volume control settings. Generally this doesn't hurt if there are three or four other tuned circuits, since the set will be selective enough to cut all local stations except the one desired.

Connecting a resistance as shown in either Fig. 3 (a) or (b) causes that tuned circuit to be thrown out of line. But if the other tuned circuits have trimmer condensers this may be compensated. The leads to the volume control and the resistor itself have capacities to ground which are across the tuned circuit. The drop in amplification is somewhat noticeable if the maximum resistance is much less than $\frac{1}{2}$ to 1 megohm.

Placing the volume controls between
(Continued on Page 42)

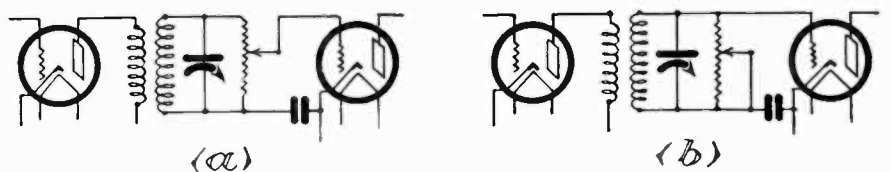

Fig. 3. Grid Circuit Control Methods

The Radio-Frequency Choke

Its Impedance, Calculation and Measurement

By GLENN H. BROWNING

THE function of a radio-frequency choke is to hinder r.f. current passing through that part of the circuit of which it is an integral part. Thus an r.f. choke is connected in series with the phones in a three circuit tuner with a fixed tickler coil and a throttle condenser to keep the r.f. current out of the phones and to force it through the condenser which controls regeneration.

Likewise a choke connected in series with the plate resistor of a resistance coupled audio amplifier keeps out high frequency currents and prevents a tendency to motorboat. A choke may be used as an impedance input from the antenna or it may be used as an impedance coupling between two r.f. stages, as

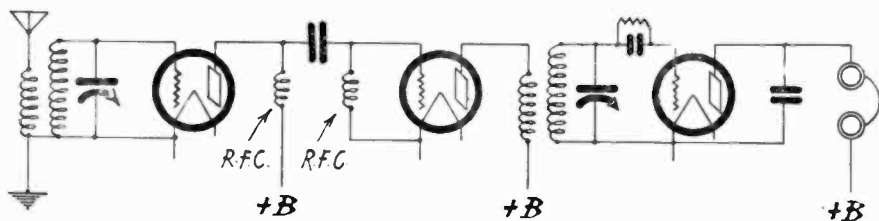

Fig. 1. Impedance Coupling Between Two R.F. Stages

in Fig. 1, so that no neutralization of the tuned stages is necessary.

In all these uses the writer has found that the important factor in a choke is its impedance to the r.f. current and not merely its inductance, in which terms it is ordinarily rated. The higher the impedance, the better the choke. In most of the cases cited it is also necessary to consider the effect of the tube capacity which may be shunted across the choke, as well as the choke's distributed capacity.

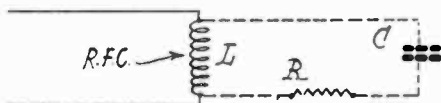

Fig. 2. Inductance, Capacitance, Resistance Relation in R.F. Choke

These capacities may be considered as a lump capacity across the winding, as in Fig. 2, which is a tuned circuit whose general impedance characteristics are shown in Fig. 3. Here the impedance is plotted against the ratio λ/λ_0 , λ being the wavelength at which the choke is being used and λ_0 the resonant wavelength to which the choke is tuned by its distributed capacity.

In curve I the resistance of the choke is small, while in curve II the resistance is ten times that of curve I. It should be noted that in the case of greater resistance, the peak of the curve shifts to the right and at the same time flattens out

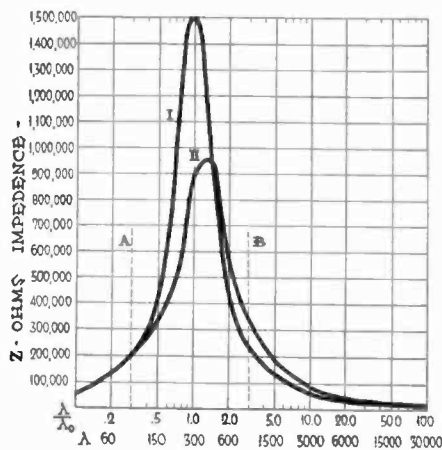

Fig. 3. General Impedance Characteristics of R.F. Choke

somewhat. These are two general curves for the circuit shown in Fig. 2.

The peak of either curve may be shifted as a whole to either the right or left by changing the inductance or distributed capacity of the choke. It is observed that the highest impedance to r.f. current may be obtained by so designing the choke coil that it will be used over a wavelength spectrum represented by the dotted lines A-B in Fig. 3.

Now that the theoretical possibilities of the radio-frequency choke have been examined, it remains to obtain some easy laboratory method of measuring their impedance and then by the cut and try method to design a choke which as nearly as possible gives the same characteristics as shown in Fig. 3.

The direct method of attack on the problem of measuring efficiency would be to put an r.f. voltage of the desired frequency across the choke and measure the current flowing through this circuit. In the average laboratory this is not possible, for an r.f. oscillator with a 210 tube will not supply much more than 150 to 100 volts without coupling very closely to the oscillatory circuit. Therefore, if the choke has an impedance of only 50,000 ohms, the r.f. current to be measured would be 2 m.a. This could be read by various means but not readily on a Rawson thermal multimeter, which

is as sensitive an a.c. meter as most laboratories have available.

In trying to measure small radio-frequency currents it occurred to the writer to measure the voltage across a fixed resistance by means of the vacuum tube voltmeters and the method was found to be satisfactory and applicable to all cases where a sufficiently large impedance was already present in the circuit so that the addition of 5000 ohms or so was immaterial. The average vacuum tube voltmeter is capable of good accuracy from about .1 to 4. volts. Thus a current of 2 m.a. through 1000 ohms would be very easy to read. The resultant circuit used is shown in Fig. 4.

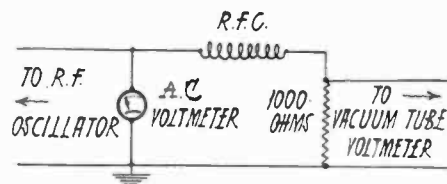

Fig. 4. Circuit of R.F. Measurements

An a.c. voltmeter reads the incoming voltage while the current through the resistance R may be readily calculated from the vacuum tube voltmeter readings.

The results of the measurements on a number of commercial chokes are shown in Figs. 5 and 6. In Fig. 5, the impedance of the chokes is shown without any external capacity placed across them. It is readily seen that choke No. 1, which was designed by the writer after a study of the theoretical possibilities, is somewhat superior to the others, having an impedance as high as 1,500,000 ohms from 300 to 350 meters and more than 200,000 ohms at its lowest point. This choke is being worked at exactly the right place as may be seen by reference to Fig. 3, while it would seem that choke No. 4 is being worked at higher wavelengths than it was designed for. Choke No. 1 has an inductance of 10 m.h., yet its impedance is higher than chokes having an inductance as low as 2.6 m.h. and as high as 168 m.h. It is queer that manufacturers should rate their chokes by inductance, which may or may not mean anything, instead of the average impedance over the wavelength band for which they are designed.

Now let us examine the impedances of these same chokes when a condenser, comparable to a tube capacity, is placed

(Continued on Page 45)

Help for the Radio Trouble-Shooter

The First of a Series of Articles Concerned with the Details of Servicing A.C. and D.C. Receivers

By J. GARRICK EISENBERG

THE advent of the a.c. receiver has intensified public criticism of the inability of some service men to correct the faults that a radio set occasionally falls heir to. So a few constructive suggestions on radio servicing should not be amiss. These include a discussion of the a.c. tube, an orderly scheme for checking trouble, and a description of apparatus which can be used without having to reach parts which are difficult of access in many of the modern receivers.

There are two types of tubes whose filaments are heated with alternating current. These are ordinarily known as the '26 type, for amplifier work, and the '27, or heater type, for use either as a detector or an amplifier.

The filament of the '26 type is connected directly to a low voltage a.c. source. Thus the grid return and the negative *B* return are connected to the a.c. supply. It is low in cost and reasonably efficient. As its filament has high inertia to movement, the a.c. fluctuations have less effect upon the electronic arrangement inside the filament structure than in the case of the usual d.c. filament. However, some fluctuation does occur and is repeated in the form of a 60-cycle plate current variation, if the tube acts as a rectifier in even the tiniest degree.

Thus it is imperative to maintain the operating point always within the straight line characteristic of the tube. Slight variations from this point, which might be permissible from distortion considerations with the d.c. filament type, will result here in a pronounced a.c. hum.

Receivers which develop such a hum, not directly traceable to the *B* eliminator, may be remedied by inserting a series grid resistance, permitting the adjustment of grid bias at will, dependent upon the applied plate voltage, so that the operating point can always be maintained on the straight line portion. A scheme for such an arrangement is shown in Fig. 1.

The resistance in series with the negative *B* return affords a negative drop, i. e. the point *X* will be more negative than the point *Y*. The value for R_1 is found from Ohm's law: the normal plate current being known the amount of voltage drop through R_1 is the product of IR . A 2-volt negative bias would be obtained, for example, if the plate current is 10 milliamperes by the use of a 200-ohm resistor ($E/I=R$).

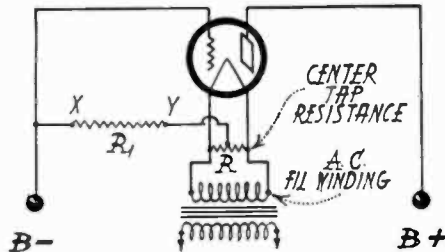

Fig. 1. Use of Grid Series Resistance to Minimize A.C. Hum

The center tap filament resistor is necessary because when the filament potential is reversed, with respect to either side of the filament, there would be a movement of electrons from the minus-*B* return to whatever side of the filament happened to be positive at the moment, if the *B* return were connected to one side of the low resistance filament. This would result in a perpetual unbalance and produce a hum dependent on this change of direction of electrons around the filament. The *B* return is therefore connected into the exact electrical center of the filament so that the movements in either direction will cancel.

To accomplish this purpose, R is of such proportions that the movement through it will be relatively small compared to the movement through the filament (the filament resistance is only about 1.4 ohms). For the sake of flexibility, R should permit of variation of the center tapping contact.

The '27 tube is more desirable and more expensive. It does not require any balancing scheme for elimination of a.c. hum, since the a.c. circuit is entirely isolated from the radio circuits proper. It uses a cathode or heater element which contains the electron-emitting substance, the a.c. filament serving merely to heat this can-like device placed around it. The cathode, being the electron-emitting source, has the grid return and negative *B* return brought back to it, for completion of the circuit. Whatever fluctuations occur in the a.c. supply, therefore, can be disregarded, with respect to filament unbalance, since the actual heating of the cathode will be uniform regardless of directional variations around the filament proper.

It might be pointed out, however, that, under this scheme, there is no way to obtain a positive bias on the grid, for detector purposes, except through the use of an external battery. Plate recti-

fication is consequently used, the grid operating on a negative bias, and the familiar gridleak-condenser arrangement not being used.

A somewhat more sensitive detector stage may be had by wiring a gridleak and condenser into the circuit, and connecting a small battery between grid and cathode to give a positive bias.

The rest of the a.c. receiver circuit is practically identical with that of a battery-operated set, except that an additional r.f. stage is often added to make up for the lack of sensitivity of the present a.c. circuit arrangements. So we can now consider actual circuit troubles and methods of analyzing these. To do so we must first determine the test equipment necessary to our purposes.

A MODERN test set must include a high resistance voltmeter having several low and high reading scales; a low and high reading milliammeter, and a low-high range a.c. voltmeter. To incorporate these several meters into the kit may mean not only a cumbersome, but an expensive arrangement, if separate meters be used for each individual purpose. But multi-scale meters are now available at reasonable cost, so that two such meters should suffice for all a.c. and d.c. tests. A multi-scale d.c. meter may easily be constructed from an inexpensive 0-10 milliammeter; a 0-100 m.a. scale may also be calibrated for this meter, by the use of a suitable shunt. We will again diverge somewhat from our main purpose to describe briefly how such a meter may be calibrated.

Ammeters are invariably wound with a few turns of low resistance wire so that they do not offer much difference of potential across their terminals. The amount of current flowing through the meter winding depends directly upon this resistance. Sensitive meters are constructed with an external resistance in parallel, so that only a tiny proportion of the actual measured current flows through the meter itself, its scale being calibrated for proportionate current flow.

If a 0-10 milliammeter be shunted with a smaller resistance, which permits only one-tenth as much current to flow through the meter winding as through the resistance, then the original scale may be used to read in multiples of 10. The shunt resistance must be of such an order that it will pass 100 milliamperes without heating or changing its resistance characteristics; it must be very accurate; and the actual calibration for

the 0-100 m.a. scale should be checked with a known standard.

To use the meter as a voltmeter, it will be necessary to add resistance in series with it. The 0-100 m.a. shunt is opened now and, since the external series resistance will be large, the actual resistance of the meter winding can be disregarded in the calculations.

According to Ohm's law, the unknown voltage E is equal to the product of a known current flow I and a known resistance R : $E = IR$. The current I also flows through the meter winding, so that the ammeter can be calibrated as a voltmeter having, say, a resistance of 1000 ohms per volt. Then, since $I = E/R$, with 1000 ohms in series with the meter winding, an indication on the meter scale of 1 milliampere would mean an applied voltage of 1; with 10,000 ohms in series with the meter, 1 milliampere would indicate an applied potential of 10; 2 m.a. a potential of 20 volts, etc., etc.

As many different values of resistance as desired may be used to secure a multi-scale meter invaluable for checking B eliminator voltages, for making emission characteristic tests, and for any use where a high degree of accuracy is requisite. The resistors should be secured from some reliable laboratory and marked for the percentage of error pres-

ent. They must be designed for a wide margin of current-carrying capacity over ordinary load conditions, otherwise they may change in value when in use.

In the test set designed by the author, a standard d.c. test unit was used, as time did not permit the necessary recalibration work. For a.c., however, two meters—one a 0-3 and 0-15 range, the other a 0-150 volt range—were used, affording a somewhat more flexible and less expensive assembly, and also permitting a more symmetrical panel arrangement, than if one single multi-scale a.c. meter had been used.

The internal connections of the d.c. test unit are shown in Fig. 2, but no attempt has been made to preserve strict accuracy here. For example, the external binding posts for d.c. voltmeter connections have been omitted, as they simply parallel the internal voltmeter circuit. The 0-500 volts resistance has been purposely left incomplete, so as not to complicate the wiring. This connection is identical with the 0-100 volt resistor.

Either a.c. or d.c. voltages may be measured at a tube socket by plugging in the cord connecting to the terminal block. The double-throw double-pole switch makes the necessary changeover for d.c. or a.c. meters.

The 0-100 milliampere shunt is not in use when the voltmeter connection is

made. The unit permits of reversed filament and grid readings being made, by a pushbutton arrangement also omitted. This simply reverses the meter terminal connections at will.

Additional apparatus in the test set includes (1) a tube rejuvenator, (2) an oscillator for accurate circuit adjustments, and which may be used as the driver for a laboratory beat frequency oscillator if desired, and (3) a high quality comparison amplifier, the uses for which are manifold. A load resistor has also been arranged in series with the milliammeter and provided with a cut-out switch, so that load conditions may be simulated for checking the output voltages of battery eliminators. This auxiliary equipment and the uses therefor will be described in detail, except for the rejuvenator, whose purpose and use should be obvious. The wiring arrangements are shown in Fig. 2.

A detailed description of the procedure to be followed in finding and correcting the troubles which may develop in a receiver is given in the next installment of this series, to be published in January RADIO. This includes a full account of the methods for using the test set whose circuit diagram is here given, especially the comparison amplifier and the oscillator.

(To be continued)

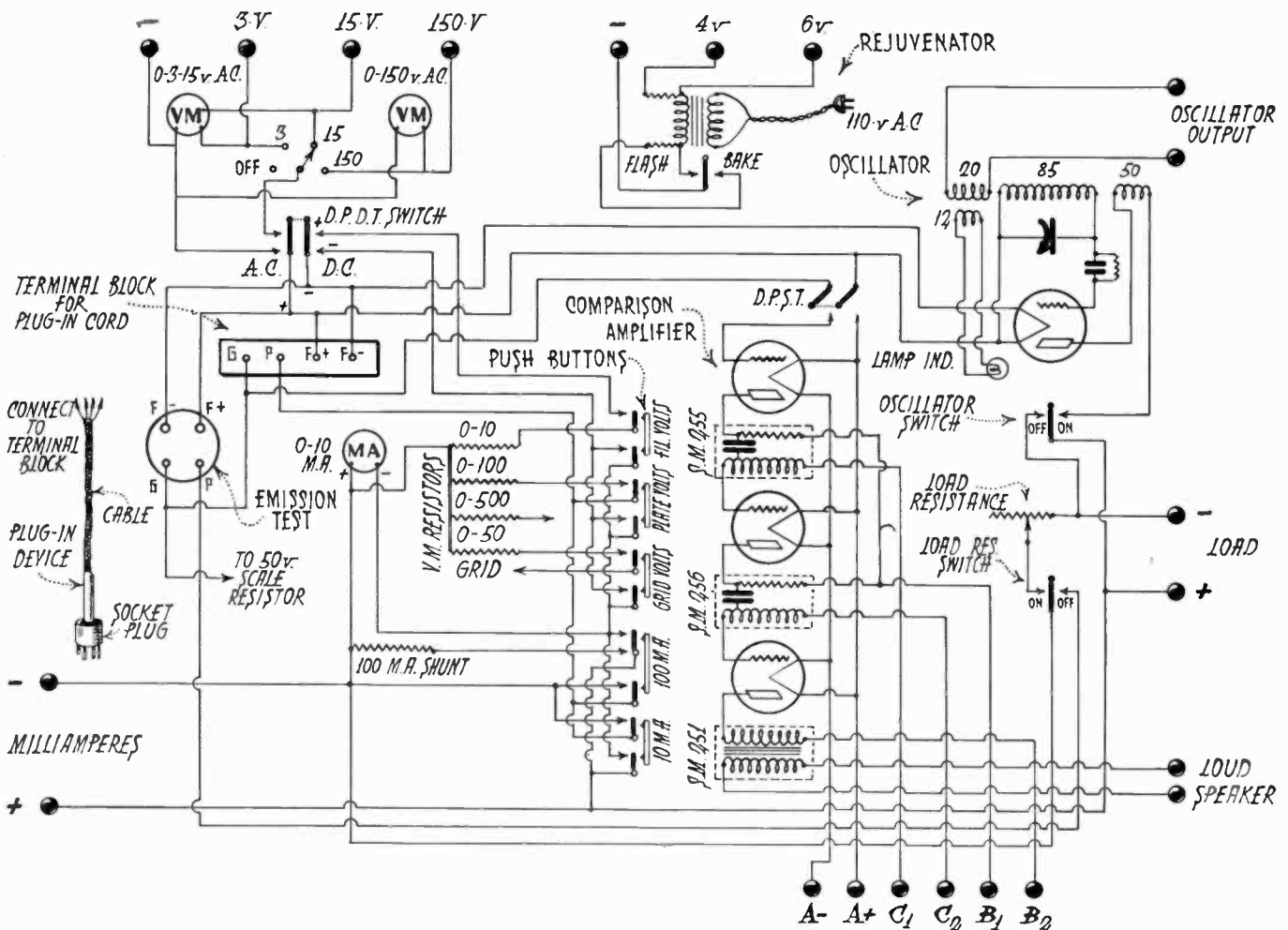
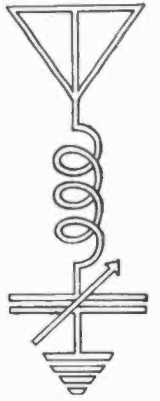

Fig. 2. Circuit Diagram for Complete Test Set

TECHNICAL BRIEFS



VERY low frequencies are seldom heard in chain broadcasts, because the connecting telephone lines are equalized to give a fairly flat characteristic between 100 and 5000 cycles per second, with a sharp cut-off beyond these limits, especially on the lower end. Furthermore most radio sets and loud speakers cut off above 100 cycles per second.

A HEATER type '27 a.c. tube will operate with longer life on 1.9 to 2.0 volts than on 2.5 volts. It takes two or three times as long to heat up, but once hot, operates practically the same as at the higher filament voltage. The insertion of a small heavy duty resistance in series with the filament leads from the power transformer will adapt almost any a.c. tube receiver for operation with lower filament voltage. The resistance can be calculated from Ohm's Law. Similarly a '71 or 112 tube will operate satisfactorily at 4.7 volts instead of the usual 5.0 volts with correspondingly greater life. The type '50 and '10 tubes will operate much longer with $6\frac{1}{2}$ to 7 volts with practically negligible effect on the sound output.

A N 0-10-ohm filament rheostat shunted directly across the moving coil of a dynamic loud speaker provides a convenient "hum" reducer at low volume of sound. Even a good a.c. receiver, with volume control in the r.f. amplifier, may have quite a bit of hum which is objectionable for soft music. Shunting the moving coil with a 4 to 8-ohm resistance will reduce the hum to nearly half of its usual intensity. Because the impedance of the moving coil increases with frequency, this scheme may reduce the high frequency response too much. So a better scheme is to use a few dozen turns of No. 26 wire wound on a $\frac{1}{4}$ -in. diameter iron bolt. Two or three taps will allow the most suitable number of turns to be found and this will give more uniform response from the speaker than when using an ordinary resistance.

MOST dynamic speakers have a low-pass filter connected across the primary of the stepdown transformer. This filter generally consists of a series inductance of from 100 to 200 milli-

henries and two shunt capacities of .01 to .02 mfd. It is designed to cut off at about 3500 cycles so that there is practically no response above 4000 cycles per second. This tends to so over-emphasize the low notes that some people dislike a dynamic loud speaker because the reproduced voice does not sound natural. This filter is ordinarily incorporated because it apparently reduces the overloading effect when a '71 tube is used with 120 to 150 volts, instead of the recommended value of 180 volts on the plate. Larger power tubes with proper voltages do not require such a filter and consequently give a brilliance of music and speech which is otherwise lacking.

Overloading may also be avoided by increasing the voltage applied to the field windings. Recent tests with several makes of dynamic speakers showed an increase of sensitivity of about 3 DB (or TU) when the voltage was increased from 6 up to 9 volts, thus calling for but half the power output from an amplifier to give the same undistorted sound output from the speaker.

Many a.c. models now use rectifiers which give from $7\frac{1}{2}$ to 12 volts across the field winding, thus giving a much more intense field across the air gap in which the moving coil is located. Increasing the current from 40 milliamperes to say 60 or 65 milliamperes through the field winding of the high-voltage type field, will increase the sensitivity 2 to 3 DB in most makes which are rated for 40 mils.

THE difficult problem of measuring antenna resistance for frequencies between 4,000 and 20,000 k.c. has apparently been solved by the pyrometer method of determining vacuum tube efficiency. Resistance is equal to power divided by current squared. The current is measured directly at the current node of the antenna. The power is measured indirectly as the difference of the tube output for the same current when the antenna is connected and disconnected.

The pyrometer method, as described by Crossley and Page in the I. R. E. *Proceedings* for October, 1928, secures identical temperature measurements of the outside glass wall of a vacuum tube when it is oscillating, with a known d.c. plate

watts input, and when it is not oscillating, with a different watts input. The difference in wattage between the two measurements represents the r.f. output power. The temperature of the glass wall is measured with a Cambridge surface pyrometer, which is essentially a flat strip thermocouple and millivoltmeter.

This method is also applicable to the measurement of condenser and coil resistances and the efficiency of vacuum tube circuits at various frequencies. Thus tests show that a 250-watt three-electrode tube is a more efficient amplifier at high frequencies than is a shield-grid tube of the same size.

AUDIO frequency transformer curves frequently show excellent low and high frequency characteristics which are not duplicated from a good dynamic loud speaker. Most of these curves are made when operating out of a 10,000 ohm impedance, representing an amplifier tube, and operating into a vacuum tube voltmeter instead of an amplifier tube. A vacuum tube voltmeter has a very low input capacity, much lower than an amplifier tube, since the plate circuit of the former has nearly zero impedance.

The input capacity of a tube depends on the plate circuit load effective resistance as shown by the expression

$$C = C_{g-f} + C_{g-p} \left(1 + \frac{\mu R_2}{R_p + R_2} \right).$$

For a tube voltmeter the second part of the equation is not much greater than the static grid-to-filament capacity C_{g-f} . However, for an amplifier tube, the second term may become 10 to 50 times as great as C_{g-f} alone and it is this total capacity which is in shunt to the audio transformer secondary. This large capacity, 50 to 100 mmfd. in shunt causes a drop in the higher frequencies, or sometimes a peak with some transformers, which is not apparent in the curves measured on single transformers.

Again, when a transformer works out of a detector tube, the plate resistance is not 10,000 ohms, but is from 15,000 to 30,000 ohms, depending on the type of tube used. These values are for grid-leak detection, since the plate impedance may be from 50,000 ohms up to several

Inside Stories of Factory Built Receivers

Stewart-Warner Model 801, Series "B"

This is a six-tube receiver with built-in power plant. The three r.f. stages and the first audio use '26 type of tubes, the detector a '27 type, and the second stage of audio two 112-A tubes in push-pull connection. The power plant supplies 1½, 2½ and 5 volts a.c. for filament supply and, by means of a full-wave tube rectifier of the '80 type, supplies 45, 67, 90 and 135 volts d.c. for plate voltage and — 4½ and — 9 volts grid bias.

The set is tuned by means of one knob-controlled drum dial which is calibrated in wavelengths and operates from gang condensers, as may be seen in the picture or circuit diagram. It has a built-in light-socket aerial for local reception and is also equipped for connection to an outside aerial for long-distance reception.

Especial care has been taken to make the condensers sturdy and permanent in adjustment. No trimmers are used nor is any adjustment necessary. The r.f. coils are tested for accuracy by means of crystal-controlled oscillators.

The audio stages are transformer coupled

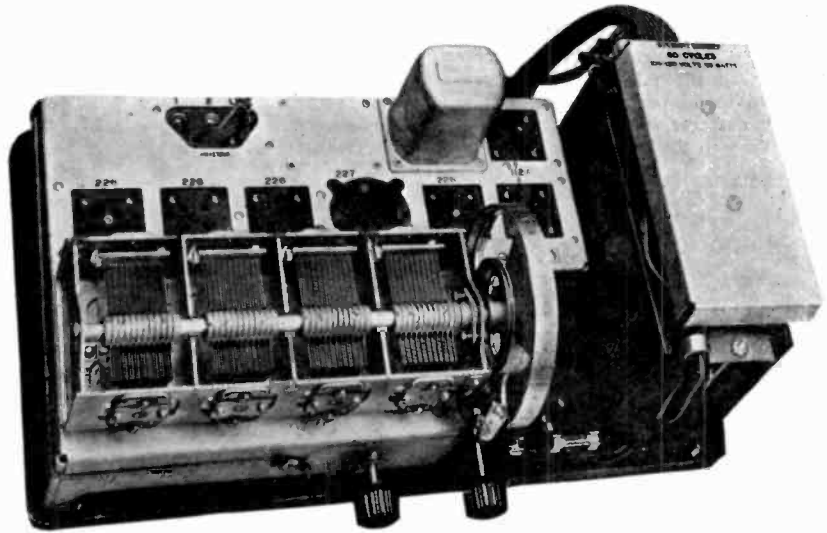

Stewart-Warner Model 801 Chassis

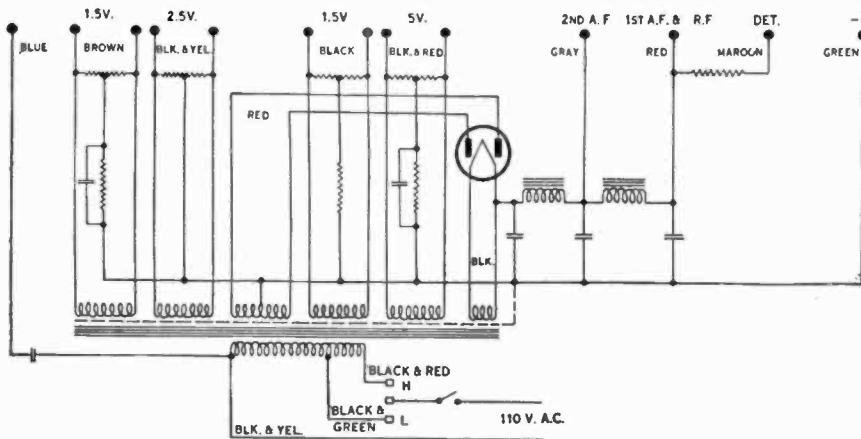

Circuit Diagram of Stewart-Warner Power Unit

and have an output transformer to protect a magnetic cone speaker. The transformers are designed for minimum coil saturation, and their impedances are accurately matched to the input and output of the tubes with which they are used. A two-tip receptacle

is provided for the attachment of an electrical phonograph pick-up unit.

The power-unit is enclosed in a shielded cabinet attached to the main baseboard. Provision is made for high and low voltage taps between 105 and 130-volt supply, 50 or

60 cycles. This is accomplished by placing a safety fuse in one of two positions. The manufacturer emphasizes the fact that dry condensers are used in the filter system.

The entire set is housed in a heavy metal cabinet, 16¾ by 10¾ by 7¾ in., decorated in gold and bronze. The escutcheon plates are of polychrome bronze and the control knobs of walnut bakelite. The cabinet shields the entire electrical assembly.

The Model 811 A C receiver is identical with the Model 801 except that it is designed for operation with 25 to 40-cycle current, 105 to 130 volts. The Model 806 is the same except that it uses d.c. 5-volt tubes. Models 801-A and 811-A have cabinets whose covers are drilled for mounting a Model 435-A speaker.

Errata Notice.—The circuit diagram of the portable a.c.-d.c. test kit on page 35 of October RADIO shows both terminals of the a.c. voltmeter connected to the same terminal on the socket. This is obviously an error on the draughtman's part as Mr. H. W. Andersen's original circuit was correct. The voltmeter terminals should be connected to separate test-plug connections.

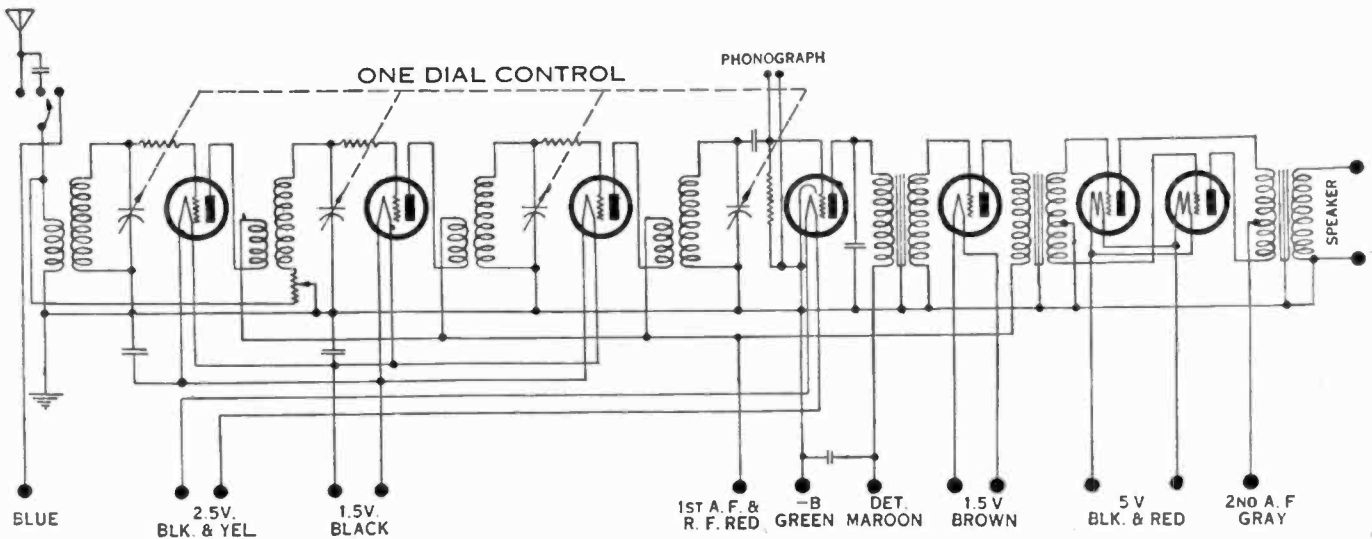

Circuit Diagram of Stewart-Warner Model 801, Series "B"

Radio Kit Reviews

AIR KING SHORT-WAVE RECEIVER

THIS list of parts provides a complete four-tube set for the reception of short-wave broadcast programs. It uses a screen grid 322 tube in the r.f. stage to increase sensitivity and avoid oscillation, a high mu 340 tube as a detector, a 301A tube with resistance coupling in the first audio stage, and

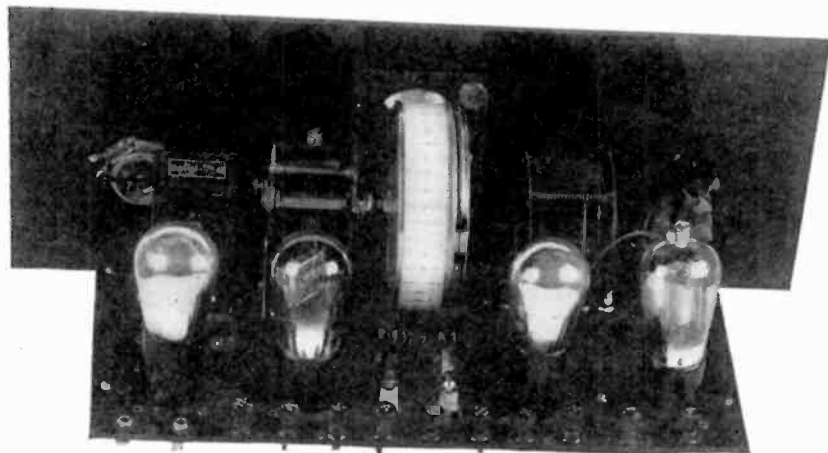

Rear View of Air King Short-Wave Receiver

a 112A power tube with transformer coupling to provide loud-speaker volume from the second audio stage. The set may also be used for the reception of code and television.

The assembly is easily made from the parts and printed directions which accompany the kit and presents a very neat ap-

pearance. The panel has but three controls: the drum-tuning dial or selector, the sensitivity knob, and the volume knob.

As may be seen in the circuit diagram of Fig. 1 the r.f. stage is aperiodic. An r.f. choke of from 85 to 125 millihenries is used as an antenna input inductance. The grid bias for the screen grid tube is obtained from the voltage drop of R_1 , which is in series with the detector filament. This is 1.7 volts negative, whereas if the drop were taken from

R_1 , in accordance with the usual custom, the grid bias would be 2.7 volts and would necessitate the use of a tapped resistance at R_1 . Both the screen grid and the plate voltage source of the r.f. tube are by-passed to the negative side of the filament, each through a .006 mfd. condenser.

The Air King short-wave coil kit is used as a tuning unit. This kit has three windings, inductively coupled, and is designed for use in the regular three-circuit regenerative receiver. L_1 is the coil that is usually used as the secondary, and it is tuned by a .00014 mfd. variable condenser. C_4 is an isolating condenser designed to keep the plate voltage off the grid of the detector tube. Its capacity is .0005 mfd. and it should have a dielectric of mica.

Ch_2 is another high impedance r.f. choke of from 85 to 125 m.h. L_2 is the adjustable coil, usually used as the primary, in the coil kit. Closely coupled to it is L_3 , the plate coil, or tickler. Regeneration is controlled by the variable feedback condenser C_6 , which is of the midget type and has a capacity of .0001 mfd. The rotor of this regeneration condenser, hence the filament of the detector tube, is grounded, a feature which eliminates body capacity.

A 65 m.h. choke is used to couple the plate of the detector coil to the input of the audio frequency amplifier. C_8 should be a mica condenser, as it must keep the plate voltage off the grid of the first audio tube. A negative bias of $3\frac{1}{2}$ volts from a C battery is imposed on the grid of this tube while 9 volts from the C battery are used as a grid bias for the second or transformer coupled audio stage.

AN AUDITORIUM POWER AMPLIFIER AND DYNAMIC SPEAKER

This outfit is designed for those who want good quality of reproduction at very great volume. The voltage amplification of each

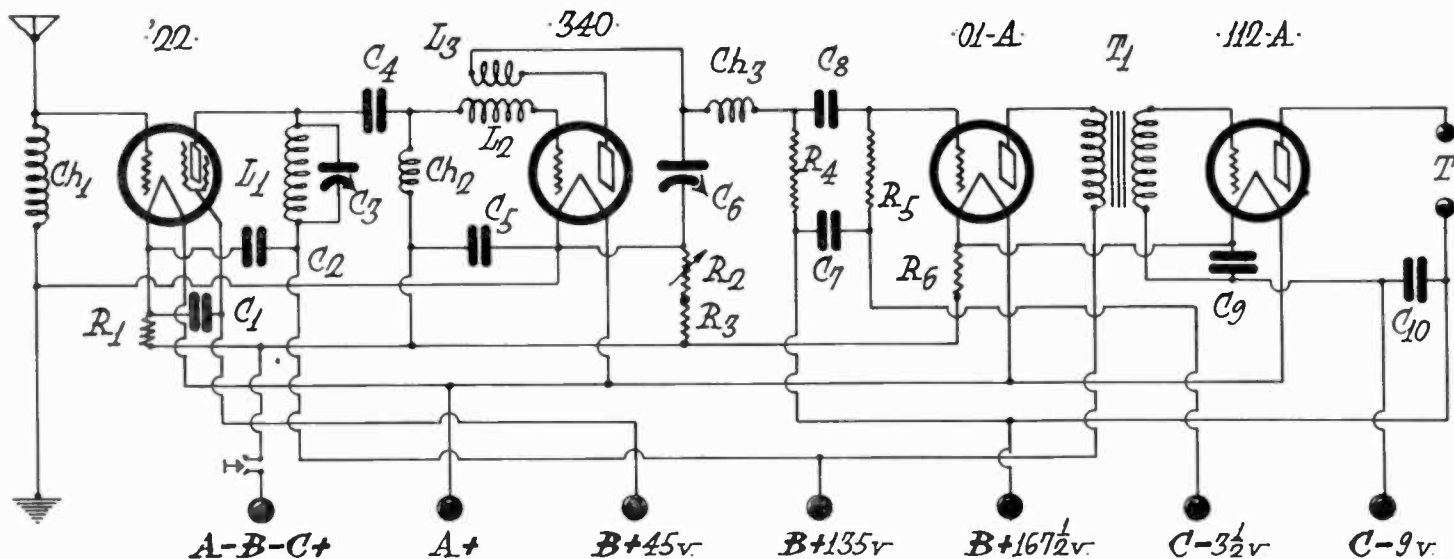

Fig. 1. Circuit Diagram of Air King Short-Wave Receiver

Ch_1, Ch_2 —R. F. choke coils, 85 to 125 millihenries.

Ch_3 —One 65-millihenry r.f. choke coil.

R_1 —One 622 amperite.

R_2 —One 20-ohm rheostat, with switch S built-in.

R_3 —One 1A amperite.

R_4 —One 112 amperite.

C_1, C_2, C_5 —Three .006 mfd. mica fixed condensers.

C_4 —One .0005 mfd. mica fixed condenser.

C_3 —One .00014 mfd. variable condenser.

C_6 —One .0001 mfd. midget type variable condenser.

C_8 —One .01 mfd. mica fixed condenser.

C_7, C_9, C_{10} —Three .5 mfd. by-pass condensers.

L_1, L_2, L_3 —One set of three Air King short-wave coils, 17 to 133 meters; each coil as the two specified windings, the third being built in the coil receptacle.

R_5 —One 0.1 meg. resistor (with mounting).

R_6 —One 2 meg. resistor (with mounting).

T_1 —One audio frequency transformer.

TJ —One pair of tip jacks.

Nine binding posts (Ant., Gnd., A minus, B minus, C plus, A plus, B plus 45, B plus 135, B plus).

One dial, one knob for rheostat, and one knob for regeneration condenser.

One 7x18 in. front panel.

One 7x14 in. subpanel.

Four sockets.

One small angle bracket for securing tuning condenser to subpanel.

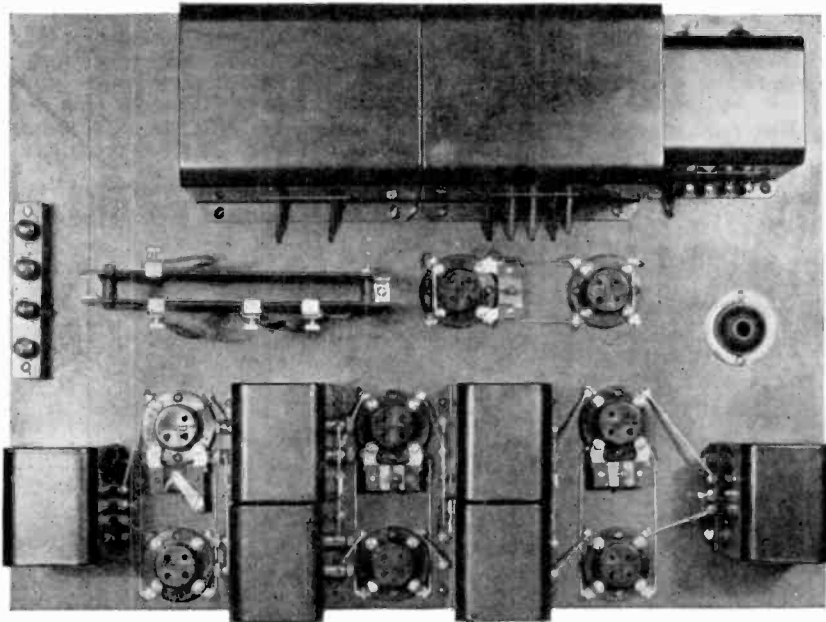

Top View of the Assembled General Radio Amplifier Kit

stage furnishes the correct input to the following stage, thus allowing all tubes to work at their normal capacities. Push-pull amplification has been used in all three stages, not only to increase the amplification, but also to minimize the a.c. hum.

One push-pull transformer was used in the input circuit of the first pair of tubes. These tubes are of the '26 type with 135 volts on their plates. They are in turn coupled to the next pair of '26 tubes through a pair of double impedances. It will be noted that the primaries and secondaries of the two impedances have been connected in series, the two B plus posts being connected together and forming the center tap for the primary, and the two filament posts similarly connected to form the secondary center tap.

The second pair of '26 tubes, with 180 volts on its plates, is coupled through transformers to the final pair of 350 tubes, whose plates are supplied with 450 volts. A push-pull output transformer designed for

the ordinary dynamic speaker handles the output of the third stage.

Power is supplied from a 600-volt, full wave transformer, and rectified by two '81 tubes. The chokes and condensers comprising the filter are all included in one metal case, which may be seen to the left of the power transformer at the top of the picture. The filament transformer is at the right. Two G. R. No. 446 voltage dividers are used in series, having a total resistance of 33,000 ohms, and from these are taken the plate taps for the three stages in the amplifier as well as any other B voltages needed for the radio set. All connections are made under the baseboard, which stands high enough off the table to hold the by-pass condensers.

The C bias for the first two stages is obtained from the drop through 3000 ohm resistances connecting the filament center taps to the grid returns and minus-B lead. One thousand ohms are used in the last stage. In each case a 2 mfd. condenser shunts the resistance.

LIST OF PARTS FOR AMPLIFIER:

- 4 Arcturus 126 tubes
- 2 CX 350 tubes
- 2 CX 381 tubes
- 8 G.R. tube sockets
- 1 G. R. 541A input transformer
- 2 G.R. 373 double impedances
- 2 G.R. 585D amplifying transformers
- 1 G.R. 541C output transformer
- 2 3000-ohm Electrad resistances
- 1 1000-ohm Electrad resistance
- 5 2 mfd. by-pass condensers
- 2 G.R. 446 voltage dividers
- 1 G.R. 440A filament transformer
- 2 1.5-ohm rheostats
- 3 G.R. 439 center-tapped resistances (60-ohm)
- 1 G.R. 437 center-tapped resistance (60-ohm)
- 1 G.R. 565B power transformer
- 1 G.R. 527A filter
- 1 Binding post strip
- 4 Eby binding posts
- Baseboard and stand-off sides

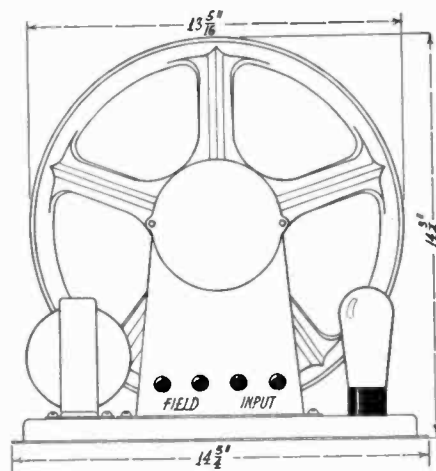

Fig. 2. Constructional Plans for the Jensen Auditorium Model Dynamic Speaker

When completed, it was found that four or more ordinary dynamic speakers were required to handle the output of the amplifier. The new auditorium model dynamic just completed in the Jensen factories was then tried and found to handle the volume very nicely. The ideal combination for public address and theater work seems to be the described amplifier working at full volume and feeding into two Jensen auditorium model dynamics.

As will be seen in Fig 2, the new model is much larger than the standard speaker, allowing room for a larger field coil and cone. The field is energized by one type 280 full-wave tube, which delivers approximately 90 milliamperes at 200 volts. The resistance of this field is 2250 ohms, although it may be wound by the user for a low voltage to be supplied by dry rectifiers of sufficient capacity to deliver the necessary 15 or 20 watts.

By taking off the two nuts which hold the back plate in place, the field coil may be removed without touching the head assembly and cone. Speakers will probably be available with an empty bobbin for the user who wishes to experiment with different types of field coils. The resistance of the movable coil is 8.2 ohms and its impedance is nearly identical with that of other types of dynamic speakers, so that standard push-pull or single tube dynamic step-down transformers will operate the auditorium model very satisfactorily. The inner core is held in spaced relation with the surrounding pole piece by means of a spacing ring fastened to the top plate. It is 1 1/2 in. in diameter. The paper cone is 11 in. in diameter and the cone angle is 40 degrees. A stroke of 3/16 in. is permitted on each side of the neutral position, allowing a total swing of 3/8 in.

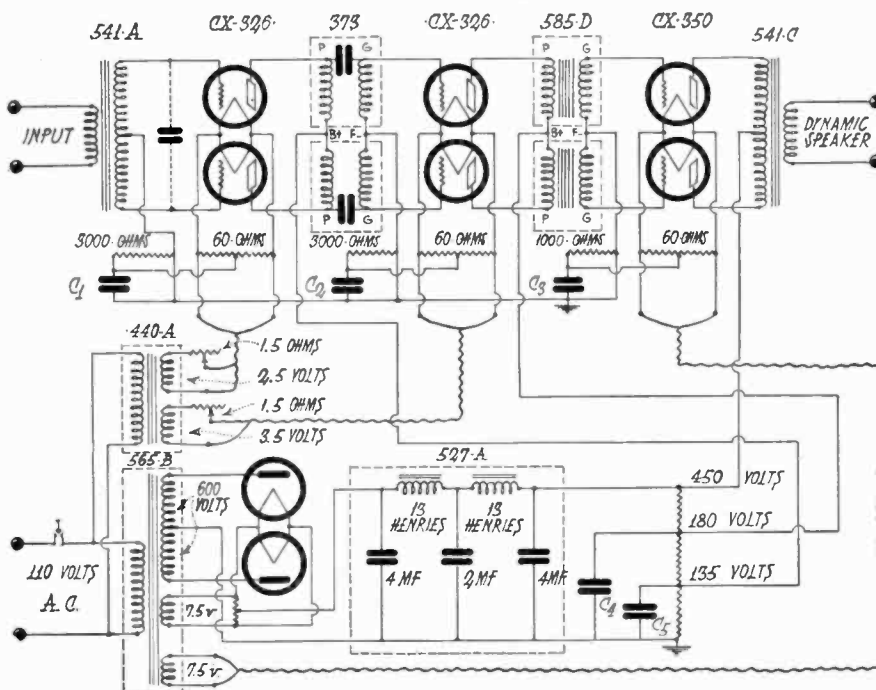

Fig. 1. Circuit Diagram of the Power Amplifier

THE 1929 BROWNING-DRAKE A. C. SHIELD GRID KIT-SET

This kit-set is capable of complete a.c. operation, with its power supply built into the set cabinet. The set has single control, with ample selectivity and sensitivity for even the most congested areas. The construction is simple and the cost of the parts much lower than in former years.

The r.f. transformer is designed to utilize the high plate resistance and amplification factor of the screen grid tube so as to give nearly twice the amplification for all wavelengths from 200 to 550 meters as is possible from the '01A type of tube. This was accomplished, with negligible capacity between primary and secondary, by increasing the coupling coefficient from a normal of 0.5 to an actual of 0.91. (The maximum theoretical value is 1.0.) The secondary is short and the primary is placed on a slot about $\frac{1}{4}$ in. from the low potential end. No neutralization is necessary and by careful placement of parts even the shielding may be omitted.

Tests have demonstrated that better selec-

The audio system consists of three stages of resistance coupling. Full constructional details are furnished with the kit.

The Electrad Truvolt Divider is intended to eliminate guesswork in "B"-eliminator design. Without a voltmeter and without laborious calculation, it provides the



proper plate and grid voltages for any type of receiver requiring a maximum of 180 volts. This is accomplished by means of five knob-controlled slider contacts which wipe

The Elkon EBH Metallic Rectifier Unit consists of four stacks of alternate electro-positive and electro-negative discs, held under pressure and mounted on a four-prong base designed to fit the standard UX tube socket. It is shielded in a ventilated alumi-

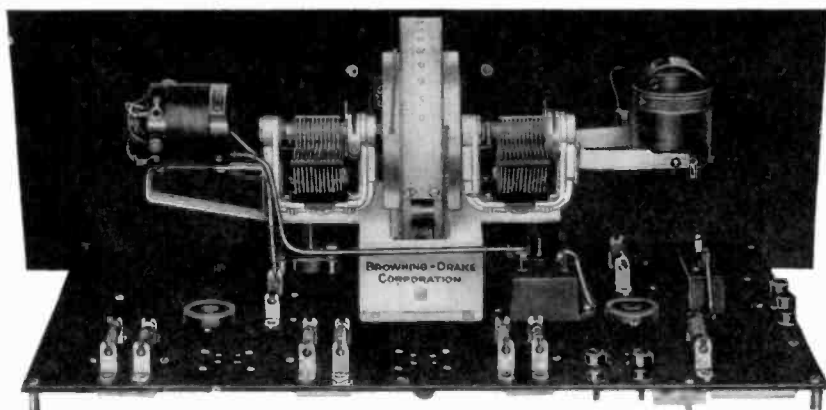
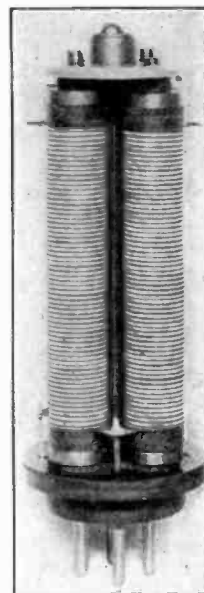

The 1929 Browning-Drake A.C. Shield Grid Kit Set

tivity is obtained with this tighter coupling. In fact it is better than that obtained from an auto transformer (tuned impedance), though the amplification of the tuned impedance system is slightly greater. One r.f. stage with tickler feed-back is used in the kit though two stages may be built by those who so desire. Single control is obtained by using a primary as shown in the diagram.

three wire-wound resistor units, 8000, 2000 and 1000 ohms, respectively, connected in series. Thus from any 220-volt rectifier-filter system it is possible to obtain 180 volts, 110-160 volts adjustable, 65-110 volts adjustable, and 20-60 volts adjustable "B" potentials, as well as 1-20 volt and 40-volt negative grid bias. This device is rated to handle 50 watts without overheating.

num housing. An alloy of aluminum and magnesium is used as the electro-positive and cupric sulphide as the electro-negative element. When an alternating current is applied to the unit a film is formed in each pair of discs which seems to unite the discs as though they were fused together, forming a conductor which offers a relatively high resistance to the passage of current from the alloy to the cupric sulphide and a relatively low resistance to the passage of current from the cupric sulphide to the alloy. In this way only one-half of the alternating current cycle is allowed to pass. By using the four stacks in conjunction with a center-tapped transformer, full wave rectification may be had, and voltages as high as 350 R.M.S. may be handled. The current output is 30 m.a. at 300 volts, 87 m.a. at 180 volts, and 130 m.a. at 90 volts. Such an assembly requires 240 couples, each of which is designed for 3 volts. A notable feature of their operation is the good voltage regulation which is maintained, thus prolonging the life of the filter condensers. The units have a life of five thousand hours.

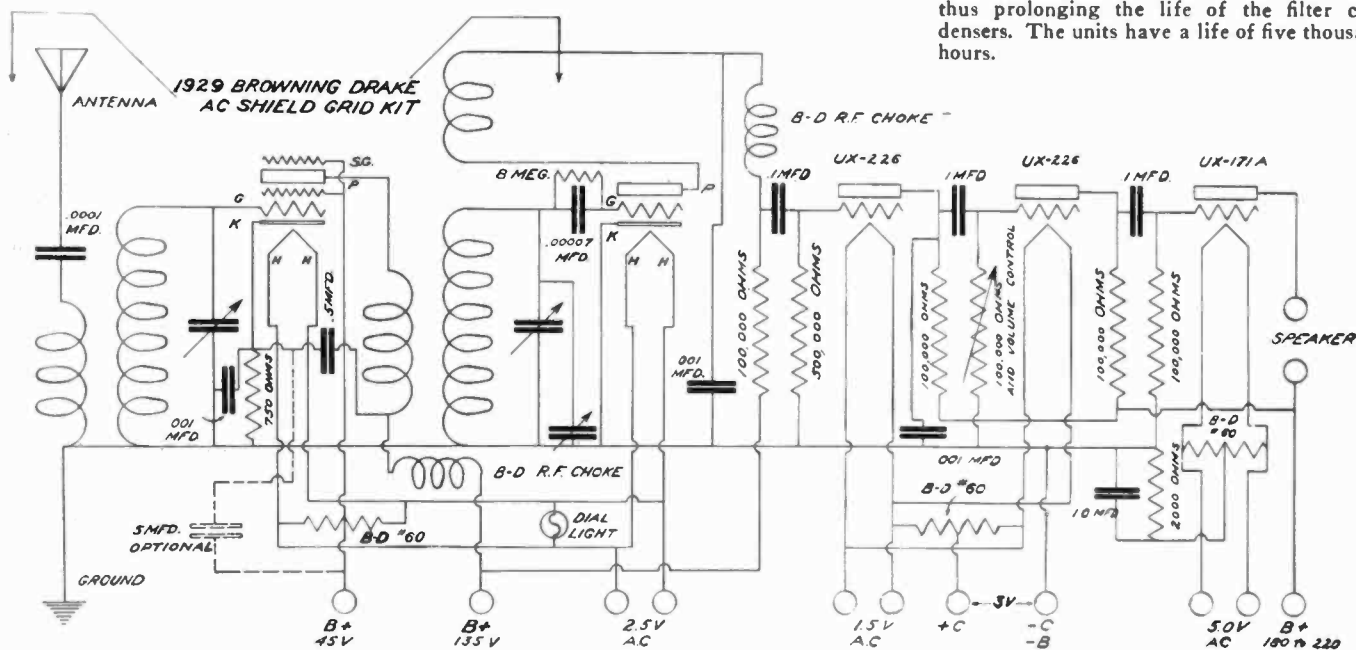

Circuit Diagram of Browning-Drake A.C. Shield Grid Kit Set

With the Amateur Operators

REVISED AMATEUR REGULATIONS

[Superseding those dated March 6, 1928]

An amateur station is a station operated by a person interested in radio technique solely with a personal aim and without pecuniary interest. Amateur licenses will not be issued to stations of other classes.

Amateur radio stations are authorized for communication only with similarly licensed stations, except as indicated below, and on wavelengths or frequencies within the following bands and at all times unless interference is caused with other radio services, in which event a silent period must be observed between the hours of 8 p. m. and 10:30 p. m., local time, and on Sundays during local church services.

Kilocycles	Meters
401,000 to 400,000	0.7477 to 0.7496
60,000 to 56,000	5.00 to 5.36
30,000 to 28,000	10.00 to 10.71
14,400 to 14,000	20.83 to 21.43
7,300 to 7,000	41.1 to 42.9
4,000 to 3,500	75. to 85.7
2,000 to 1,715	150. to 175.

Amateur radio telephone operation will be permitted only in the following bands: 60,000 to 56,000 k.c. (5.00 to 5.35 meters), 3550 to 3500 k.c. (84.50 to 85.70 meters), 2000 to 1715 k.c. (150 to 175 meters).

Amateur television and operation of picture transmission apparatus will be permitted only in the following bands: 60,000 to 56,000 k.c. (5.00 to 5.35 meters), 2000 to 1715 k.c. (150 to 175 meters).

Spark transmitters will not be authorized for amateur use.

Amateur stations must use circuits loosely coupled to the radiating system or devices that will produce equivalent effects to minimize key impacts, harmonics, and plate supply modulations. Conductive coupling, even though loose, will not be permitted, but this restriction shall not apply against the employment of transmission line feeder systems to Hertzian antennae.

Amateur stations are not permitted to communicate with commercial or Government stations unless authorized by the licensing authority except in an emergency or for testing purposes. This restriction does not apply to communication with small pleasure craft such as yachts and motor boats holding limited commercial station licenses which may have difficulty in establishing communication with commercial or Government stations.

Amateur stations are not authorized to broadcast news, music, lectures, sermons, or any form of entertainment, or to conduct any form of commercial correspondence.

No person shall operate an amateur station except under and in accordance with an operator's license issued to him by the Secretary of Commerce.

THE NEW "Q" SIGNALS

The "Q" signals, long used as abbreviations for questions which are asked or answered in code, have been completely revised by the Washington convention, to become effective January 1, 1929. As many changes have been made in the meanings of the old signals, it is necessary for every operator to learn the new code.

The most notable change is the complete abandonment of the QST signal and the substitution of CQK as a general call with a request for reply. Likewise CQ is again to be used as a general call without request for reply.

The signals are herewith listed as an-

swers, it being understood that the same signal, when followed by a question mark in code, is the question to which the answer is to be given. This list gives only the QR and the QS signals, as the QT signals are concerned principally with radio compass bearings.

- QRA The name of my station is —.
- QRB The distance between our stations is —.
- QRC The charges of my station are paid by —.
- QRD I am going to —.
- QRE The nationality of my station is —.
- QRF I come from —.
- QRG Your wavelength (or frequency) is —.
- QRH My wavelength (or frequency) is —.
- QRI Your tone is bad.
- QRJ Your signals are too weak.
- QRK Your signals are good.
- QRL I am busy.
- QRM I am being interfered with.
- QRN I am troubled by atmospheric.
- QRO Increase power.
- QRP Decrease power.
- QRQ Send faster.
- QRS Send more slowly.
- QRT Stop sending.
- QRU I have nothing for you.
- QRV Send a series of V's.
- QRW Advise — that I am calling him.
- QRX Wait until I have finished.
- QRY I will call you at — o'clock.
- QRY Your turn is No. —.
- QRZ You are being called by —.
- QSA The strength of your signal is
1 (Hardly perceptible; unreadable.)
2 (Weak; readable now and then.)
3 (Fairly good; readable with difficulty.)
4 (Good; readable.)
5 (Very good; perfectly readable.)
- QSB The strength of your signals vary.
- QSC Your signals disappear at intervals.
- QSD Your keying is bad; unreadable.
- QSE Your signals run together.
- QSF Your automatic transmission fades out.
- QSG Transmit the telegrams by a series of —.
- QSH Transmit one telegram at a time, repeating it twice.
- QSI Send the telegrams in alternate order without repetition.
- QSJ The charge to be collected is —.
- QSK Suspend traffic till —.
- QSL I acknowledge receipt.
- QSM I have not received your acknowledgment of receipt.
- QSN I cannot receive you now. Continue to listen.
- QSO I can communicate with — directly or through —.
- QSP I will relay to — free of charge.
- QSQ Send each group or word once only.
- QSR The distress call received from — has been attended to.
- QSU Send on — meters (or k.c.) waves of Type
A1 (Unmodulated C.W., varied by telegraphic keying.)
A2 (C.W. modulated at a.f., also with telegraphic keying.)
A3 (C. W. modulated by speech or music.)
B (Damped waves.)
- QSV Shift to — meters (or k.c.) and continue after sending several V's.
- QSW I will send on — meters (or k.c.) on waves of Type —.
- QSX Your wavelength (frequency) varies.
- QSY Send on wave of — meters (or k.c.) without changing type of wave.
- QSZ Send each word or group twice.

CALLS HEARD

At KDUV, by E. O. Schwerdtfeger, on Pacific Ocean between 170th and 160th Eastern Meridians (latter part of August, 1928), Great Circle Route, Seattle-Shanghai

2uo, 3xw, 5cj, 6acz, 6alm, 6akg, 6aov, 6arb, 6asj, 6avj, 6avl, 6bdy, 6bhj, 6bqh, 6ch, 6chl, 6chn, 6cut, 6cyx, 6dfm, 6dfs, 6dkh, 6dkv, 6dlx, 6dnn, 6dwi, 6dwn, 6dwz, 6dxt, 7aax, 7ac, 7ar, 7akv, 7alk, 7alr, 7ep, 7mi, 7mo, 7nr, 7ou, 7sw, 8bor, 9hak, 9pl, 9rm, nc-5an, oz-2gp, op-1cm, op-1dr, op-1hr, gdzv, jdr, jpp, jxr2, kewe, ktz, kzet, rdx, xda, xmd.

By EF-8XD (Near Lyon, France)

NU: U. S. A.: On QRH 37 band: (1abd), 1abv, (1aba), 1adb, 1ade, (1adm), 1afb, 1age, (1aha), (1alr), (1als), 1aqp, (1aqt), 1arb, 1asd, 1asp, 1asv, 1aue, 1auj, 1auz, (1avk), 1axq, 1axx, 1bbe, (1bft), 1bjx, 1bke, 1bnn, (1bux), 1cak, 1cki, 1cmp, (1cpc), 1cmx, 1cuf, 1eh, 1gc, 1mx, 1oh, 1nq, 1ry, 1xl.

2aad, 2adl, 2aeb, 2aoc, 2aou, 2afb, 2afo, 2afw, 2afz, 2ahh, 2ajg, (2aib), (2akj), 2alu, 2api, 2apv, 2arq, 2ass, 2atq, 2atr, 2atx, 2aub, 2as, 2avw, 2az, 2hav, (2baz), 2bbe, 2bcc, 2bda, 2bdt, 2bck, 2bin, 2ber, 2bjg, (2bif), 2bgi, 2bix, 2bmj, 2bfp, 2bke, (2cin), 2crb, 2cqd, 2com, (2cuq), 2cz, 2cxl, (2cyx), 2dg, 2fd, 2fs, (2ge), (2gx), 2hc, 2hr, (2jd), 2nm, 2rt, 2rs, 2uc, (2sz), 2wr, 2zz, 3afj, 3afx, (3afu), 3age, 3ahh, 3aih, 3aif, (3anh), 3akw, 3aod, 3aqm, 3ard, 3aic, 3ark, 3aso, 3avd, 3aws, 3blp, 3bqv, 3cc, 3cdl, (3cig), (3cin), 3cki, 3ez, 3lz, 3lw, 3qc, 3sz, 3sn, 3vg.

4aba, 4abl, 4abr, 4abw, 4aby, 4acn, 4acv, 4acz, 4acf, 4aej, 4ack, 4afa, (4ahl), 4ahy, 4afc, 4aou, 4bb, 4bl, 4br, 4cj, 4ea, 4ge, 4js, 4hy, 4nu, 4oc, 4fl, 4qs, 4td, (4tk), 4th, 4uc, 4vl, 4wc. 5acl, 5afe, (5atf), 5ayl, 5jc, 5vx, 5yb. (8adg), 8aht, 8apd, 8ary, 8awu, (8baf), 8bbg, 8bbi, 8bbs, 8bhi, 8bhj, 8bjb, 8bm, 8bou, (8box), 8bpl, (8bqr), 8bri, 8brh, 8bto, (8bth), 8btr, 8ccg, 8cft, 8ciw, 8cnt, 8ccs, 8ctl, 8dcc, 8dcm, 8did, (8dnt), 8don, 8drj, 8dsy, 8duw, 8gz, (8hx), 8kx. 9ama, 9ari, 9be, 9bfc, 9cad, 9cee, 9cmm, 9cnd, 9cuc, 9ecz, 9ecx, 9ejo, 9eln, 9ekx, 9epa, 9fax, 9fq, 9fq, 9fs, 9tm.

Wnp, nrm. On QRH 20 band: 1abt, 1aff, 1ak, 1alb, 1arq, 1aze, 1awe, 1bat, 1bcv, 1bux, 1byv, 1cjh, 1cki, (1cmx), 1ckb, 1fs, 1ka, 1mo, 1mx, 1qh, 1r, 1sz, 1ry, 1dv. 2aca, 2aer, (2aib), 2alw, 2api, 2arb, 2ary, 2avl, 2avz, 2ays, 2bad, 2bfq, 2cuq, 2cxl, 2nd, 2nm, 2ow, 2sj, 2rs.

3adm, 3aqm, 3aqi, 3awq, 3bph, 3gi, 3nr. 4aep, 4km, 4wm. 6wb, 6zdz. 7acs. 8adg, 8ail, 8asf, 8aw, 8aq, 8baz, 8bdt, 8bc, 8bfw, 8bgx, 8bz, 8clp, 8cnh, 8cnz, 8cpr, 8dcc, 8dod, 8dog, 8dkt. 9adn, 9bcn, 9bxi, 9crr, 9cuh, 9bqy, 9eap, 9ejo, 9ell, 9eln, 9fci, 9fof.

Wnp. NC: (1br), 1ad, 3he, 2ba, 2ca. NF: 6ol2d. NJ: longban, 2pa. NM: 1rz, 8a. NN: 1nic, 7ni. NQ: 2ac, (2iq), 2cf, 2sf, (2ro), 5ay, 5by, 5cx, (5ea), 5fc, 5fl, 7cx. NR: 4ac. NS: 1fmh. NT: 2fp. NZ: fr5.

Cr'd to any of above on request. All QSL's appreciated! All cards answered! QRK ef 8XD?? QSL via R.E.F.

PUBLICATIONS RECEIVED

Reprints from the Bureau of Standards *Journal of Research* for October, 1928, include papers No. 16 and 19, which can be obtained from the United States Government Printing Office, Washington, for 10 and 15 cents respectively. No. 16 by F. W. Grover, describes methods for the derivation and expansion of formulas for the mutual inductance of coaxial circles and for the inductance of single-layer solenoids. No. 19 by Haraden Pratt and Harry Diamond, illustrate and describe receiving sets used for aircraft beacons and telephony.

Catalog No. 135 from Insuline Corporation of America, New York City, illustrates and describes their radio and television products. These include radio panels, tubing, spaghetti, insulated wire, dials, knobs, sockets and insulators, as well as complete television kits and parts for experimental and dealer display use.



The COMMERCIAL BRASSPOUNDER

A Department
for the Operator
at Sea and Ashore



Edited by P. S. LUCAS
R. O. COOK, Assistant

WELL, now that all the new calls are memorized, it is time to tackle the "Q sigs." The committee certainly was feeling fit when it came to that page in the "regs," as the results of its tussle ably show. In addition to the fifteen new signals adopted, twenty-five of the old ones have been given entirely different meanings.

No longer does QRV indicate readiness, nor QRW mean that your pipe needs filling. The old insult, QSC, has been passed down to QSD. QSK is replaced by QTA, and the QTA request for a repetition is "lost and gone forever." ?AA, ?AB, ?AL and ?BN are supposed to take its place. QTA will be mourned.

We have received several disgusted explosions at the "bench-warmers" who evolved these "useless, confusing and senseless changes," (please note the quotes) but we fail to see how squawking will help matters. And when you come right down to the point, it can be seen, and might as well be admitted, that the new list is far superior to the old. Subjects appear in better alphabetical order; e. g., in the 1912 list the subject of bearings and position was scattered from QRC to QTE; now it is held to one section which is given over exclusively to bearings, beacons, and positions.

No, the only thing to do is to promptly forget that there ever was another list of abbreviations, and use the new one consistently. The miscellaneous abbreviations likewise chosen at the conference should also be adhered to consistently. We have always wanted a universal abbreviation vocabulary; now we have it. Let's make use of it.

TAKING THE SCREEN GRID TUBE TO SEA

By HARRY F. WASHBURN

THE four element tube has been on the market for more than a year now, but not until it has reached the stage of obsolescence will it find its way into commercial ship receivers. Therefore I did a little experimenting on my own in order to determine whether or not the claims made for the screened grid tube as a radio frequency amplifier in a broadcast receiver would hold good on the longer waves. The results have been so satisfactory that they justify a description of my 550 to 1400-meter receiver, so here goes:

One screened grid (UX-222) tube was used in the stage of radio frequency, with '99s as detector and audio amplifiers. The only reason I used '99s in the last three sockets was because no six-volt battery was available. The r.f. stage is untuned in order to cut down the number of major controls as well as to prevent undesirable oscillation if the stage is not heavily shielded. The detector circuit is the same old standby which

has been running along on all six since Babe Ruth started to hit homers.

To improve selectivity the plate supply for the '22 is shunt fed through an r.f. choke and the circuit coupled to the detector by a .001 mfd. fixed condenser. The choke must be a good one and large enough to keep the r.f. in its place. The Silver-Marshall No. 276 choke is especially manufactured for receivers working on waves over 600 meters and is to be recommended, both for the aperiodic tuning coil in the grid circuit and for the r.f. choke.

The detector coil consists of 110 turns on a 3-in. tube with a tickler rotating inside. Plug-

WHO IS THE RADIO OPERATOR?

A Few Caustic Comments Which Go Right to the Point

By GEORGE L. BACON
Opr. S. S. Edward Luckenbach

AN old lady visiting a ship one day asked one of the officers if he were the wireless operator.

"No," he replied, "I am the captain."

"Well," she remarked, "That's a good job too."

Somehow or other the wrong impression

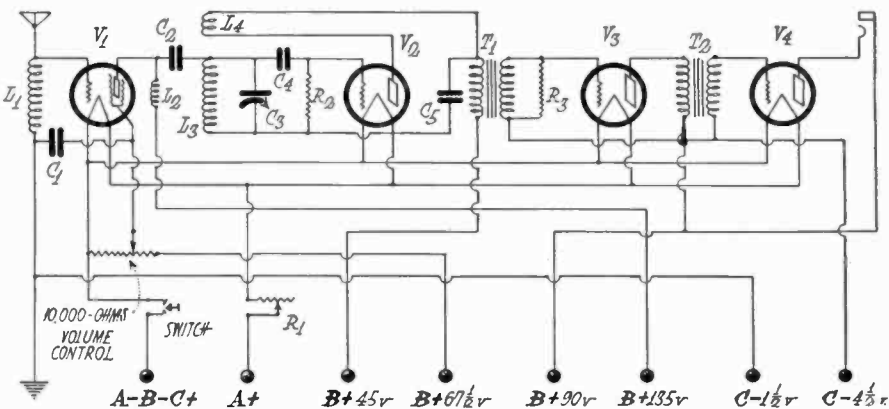

Fig. 1. Circuit Diagram of the Four-Tube, Screened Grid, Ship Receiver

- | | |
|---|---|
| L ₁ —Silver-Marshall R.F. Choke No. 276. | C ₅ —Sangamo .002 mfd. fixed condenser. |
| L ₂ —Silver-Marshall R.F. Choke No. 276. | V ₁ —UX-222 or CX-322 tube. |
| L ₃ —110 turns No. 22 d.c.c. wire on 3-in. tube. | V ₂ —UX-199 or CX-299 tube. |
| L ₄ —40 turns No. 28 d.c.c. wire on 2 1/4-in. rotor inside grid end L ₃ . | V ₃ , V ₄ —UX-199 or CX-299 tubes. |
| C ₁ —1 mfd. Tobe by-pass condenser. | R ₁ —15-ohm rheostat. |
| C ₂ —Sangamo .001 mfd. fixed condenser. | R ₂ —5-megohm Tobe grid leak. |
| C ₃ —0.005 mfd. variable SLF condenser. | R ₃ —1/4-megohm Tobe fixed resistance. |
| C ₄ —Sangamo .00025 mfd. fixed condenser. | T ₁ , T ₂ —Audio frequency transformers, 3 1/2-1 ratio. |

in coils may very well be used here so that the range of the set could be increased to cover from 200 to 3000 meters. When using plug-in coils, however, the capacity method of obtaining regeneration should be used, as the old style of varying the coupling is unsatisfactory. The resistance across the secondary of the first audio transformer makes oscillation control smoother when tuning for CW.

One tuning control and one regeneration control are all that are needed, as the r.f. stage is aperiodic. Yet it is amply selective and its sensitivity is astonishingly greater than average for these bands. The 10,000-ohm potentiometer varying the voltage to the screen affords a very handy volume control, eliminating the necessity of detuning the regeneration or tuning controls.

is out in the world. The main reason for this, aside from the operators themselves, lies in the radio schools throughout the country.

In the present era of radio, many male humans (mostly boys) who become enshrouded in the net of fascination which goes hand in hand with radio, find themselves at sometime or other scrutinizing an advertisement that reads something like this:

SEE THE WORLD—VISIT FOREIGN LANDS—BE AN OFFICER—EAT IN THE SALON—EARN GOOD MONEY, ETC., ETC.

In some cases a picture of a dashing young thing dressed in white is shown; two gold bars weighing down each shoulder. He is standing on the bridge, (most masters don't
(Continued on Page 34)

Just a few extra cents bring you more active materials, and 25% to 30% longer life

IF YOU could get two or more months' "B" battery service for 20 or 25 cents it would seem like a bargain, wouldn't it?

We offer you just about that.

For instance, if you have been using medium size "B" batteries, such as the Eveready Medium Size No. 772, next time buy the Eveready Layerbilt "B" Battery No. 485. This will last 25% longer, though it costs you only 20 cents more.

If you have been using heavy duty batteries, such as the Eveready Heavy Duty "B" Battery No. 770, when you need new ones buy the famous original Eveready Layerbilt No. 486, which has the same outside dimensions but lasts 30% longer, though costing only 25 cents more.

Both these Eveready Layerbilts contain flat cells instead of cylindrical ones. The flat cells pack together tightly, occupy all available space inside the battery case, and so make it possible to put considerably more active, current-producing materials in the battery. That's why Eveready Layerbilts last 25% to 30% longer than cylindrical cell Evereadys of the same size, making them the most economical Evereadys, size for size.

Every Eveready Layerbilt "B" Battery has the word "Layerbilt" printed large on the label. Look for that word, to make sure you get the real, longer-lasting Eveready Layerbilt.

NATIONAL CARBON CO., Inc.
New York San Francisco
Unit of  and Carbon Corporation



\$2.95

medium size
Eveready Layerbilt
"B" Battery



\$4.25

heavy duty
Eveready Layerbilt
"B" Battery

TUESDAY NIGHT IS EVEREADY HOUR NIGHT. East of the Rockies—9 P. M. Eastern Standard Time, through WEAJ and associated N. B. C. stations. On the Pacific Coast—8 P. M. Pacific Standard Time, through N. B. C. Pacific Coast network.



EVEREADY
Radio Batteries

Layerbilt construction is a patented Eveready feature. Only Eveready makes Layerbilt Batteries

SEE AND HEAR THE NEW EVEREADY RADIO SETS

Tell them you saw it in RADIO



Melodies Caught
in Flight with

Cunningham
RADIO TUBES

As the Yule-logs crackle and music fills the air, enjoy the Christmas melodies to their utmost by having new Cunningham Radio Tubes in every socket of your radio.

These "ambassadors of joy" make delightful Christmas gifts.

E. T. CUNNINGHAM, Inc.
New York Chicago San Francisco

Manufactured and sold under rights, patents and inventions owned and/or controlled by Radio Corporation of America.



Choose from
the Year's Most
Successful Designs

—practical helps for amateur
and professional Builders

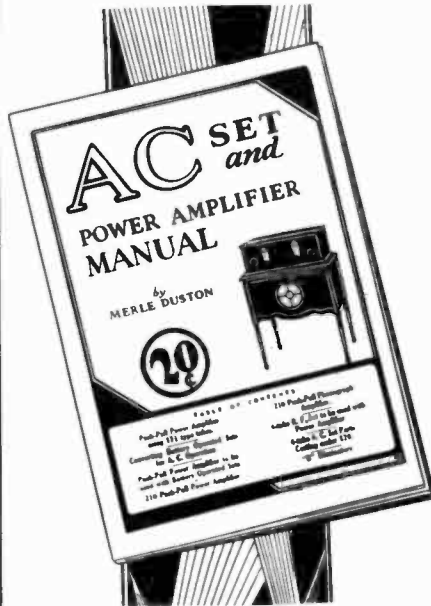

Here are described—and illustrated—in understandable, interesting terms, the newest designs in A C Power Amplifiers. Every single one has been proved practical.

This authentic A C Manual is the work of Merle Duston, well-known engineer and the author of many radio text books. Mr. Duston has condensed in this valuable volume the best efforts of the industry covering the past year of Radio's greatest development.

A limited supply of this splendid A C Manual is available through the Dongan Laboratories. Send 20 cents for a copy to be mailed to you.

DONGAN ELECTRIC MFG. CO.

2981-3001 Franklin St., Detroit, Mich.

TRANSFORMERS of MERIT for FIFTEEN YEARS

**More "A" Power
For Less Money!**

With the Set Builders discount card you can purchase a

KNAPP "A" POWER KIT
at a liberal discount.

Write me today for full details telling about this new money-saving plan for set builders.

DAVID W. KNAPP, Pres.
Knapp Electric, Inc.

Division of P. R. Mallory & Co., Inc.

Room 416, 350 Madison Ave., N. Y. C.

**USE THE CLASSIFIED ADS
IN "RADIO"**

They Bring Results

Tell them you saw it in RADIO

Set Builders
Circuit Designers
Radio Engineers

Here is a
Book
You Need!



Send for it Today



When the leading set manufacturers of the country choose Yaxley parts there is something more than even an outstanding reputation at work.

Yaxley parts are used in vital places; if they were not entirely dependable, these set manufacturers would not stake trade and customer satisfaction on their performance.



YAXLEY MFG. CO.

Dept. A, 9 So. Clinton St.

Chicago, Ill.



THE COMPLETE LINE OF QUALITY RADIO PARTS

DESIGNED TO RENDER UTMOST IN SERVICE

FROST-RADIO

PRICED TO GIVE YOU UTMOST IN VALUE



FROST VOLUME CONTROL

Gives complete, stepless and wonderfully smooth control of volume and oscillation. Wearproof roller contact arm, Bakelite case and dust cover. \$2.00 and \$2.25.



FROST VOLUME CONTROL WITH A.C. SWITCH

We equip our famous Volume Control with approved A.C. Snap Switch tested to carry 250 volts at 3 amperes, so that both switch and volume control may be handled by single knob. \$2.75 and \$3.00.



FROST VOLUME CONTROL WITH D.C. SWITCH

Equipped with sturdy German silver switch mounted on Bakelite panel, and with switch points fitted with sterling silver contacts, this Volume Control gives quick operation, positive-locking of position and saves space. For battery operated sets. \$2.35.



FROST GEM VOLUME CONTROL

Identical with our standard size Volume Control units except in size. Gem units are only 1 1/2 in. in diameter, and 3/8 in. thick. Great space savers. \$2.25 and \$2.50.



FROST ALL-BAKELITE CABLE PLUG

Terminals cannot work loose even when overheated. Color code moulded into Bakelite. Best quality cable, with colored rubber insulation on wires. Has 5 ft. seven strand braid covered cable. Plug and cord only, \$2.25. Baseboard or sub-panel socket, 75c.



FROST CONVENIENCE OUTLETS

Fit std. outlet box. Brush brass or Bakelite plates. \$1.00 to \$3.25.



FROST HUM BALANCER

Simply turn the slotted headshaft with screw driver to regulate. Smooths the ripple out of A.C. current. Precision built. \$1.00.



FROST GEM RHEOSTATS

Made to deliver a service that is not usually expected from little rheostats like these. Mighty good little rheostats, taking up little space and supplied either plain or with D.C. switch. Easy to solder to. Plain, 75c. With switch, \$1.00.



FROST APPROVED A.C. SWITCH

Single hole mount 110 volt A.C. Snap Switch. Tested to 250 volts, 3 amps. Underwriters' approved. 75c.

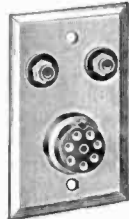

FROST FIXED RESISTANCES

Die cut flexible Bakelite strip holds windings firmly in place. Terminals are staked into Bakelite. .4 to 1000 ohms. Also as center tapped resistances, 6 to 64 ohms. 15c to 50c.



FROST MOULDED MICA CONDENSERS

Cannot be affected by moisture or climate. Moulded Bakelite with finest mica dielectric. Easy to attach. 45c. to 90c.

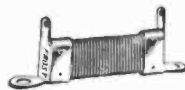

FROST BY-PASS CONDENSERS

Made from finest materials, thoroughly seasoned, vacuum impregnated and hermetically sealed. Accurate capacities and conservative voltage ratings. 1 to 2 mfs. 80c to \$2.00.

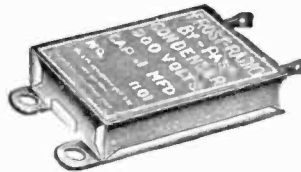

FROST HEAVY DUTY FILTER CONDENSERS

We use only finest quality linen paper and highest grade foils in building these Filter Condensers. Conservative ratings. Designed to give longest service with entire freedom from trouble. .5 to 2 mfd. \$1.40 to \$7.00.

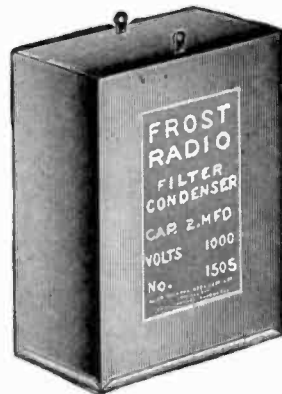

FROST BAKELITE RHEOSTATS

Long the standard air-cooled Bakelite Rheostat, as well as the original of this type. Resistance wire is wound on die cut Bakelite strip over moulded Bakelite frame. Wide choice of resistances. \$1.00 and \$2.50.



FROST BAKELITE RHEOSTATS WITH D.C. SWITCH

Cleverly mounted German silver D.C. battery switch is firmly attached to Bakelite panel on back of rheostat, affording quick on and off control of filament current. 2 to 75 ohms. \$1.35.



Coupon Brings Complete Frost Catalog

It costs but little and contains a vast amount of valuable information about rheostats, volume controls, switches, jacks, plugs, condensers, circuits, etc. It's a book every fan should have. Fill out and mail coupon today for your copy.

HERBERT H. FROST, INC.

Main Office and Factory: ELKHART, IND.

New York City

CHICAGO

San Francisco

HERBERT H. FROST, INC.

160 North La Salle Street, Chicago

Send me your new Frost Data Book, containing valuable radio information and facts about your complete line of parts. I enclose 10c.

My Name

Street Address

City..... State.....

(Are you a professional set builder?.....)

POWER



"They Cost No More—But Last Longer"

PRONOUNCED SEE—CO

RADIO TUBES

*Steadier performance
—longer life*

IT'S performance that counts! And it doesn't take a critical ear to note the great improvement a set of CeCo Tubes makes in reception.

It's a simple matter to avoid disappointing results by making sure that a CeCo Tube occupies each socket of your set.

The exclusive CeCo method of evacuation is largely responsible for their outstanding performance and is directly responsible for the longer operating life for which CeCo Tubes have gained a country-wide reputation.

No matter what your tube requirements may be—there are CeCo Tubes made to meet every radio need in both A.C. and D.C. types as well as in "special purpose" types which are obtainable nowhere else.

Try a set of CeCo Tubes and you, too, will find how much better they improve reception. A CeCo dealer will gladly advise you which types to use to obtain the best results.

CeCo MANUFACTURING Co. Inc.
PROVIDENCE, R. I.

WHO IS THE RADIO OPERATOR?

(Continued from Page 30)

allow operators on that sacred shrine), is all smiles, and is shown gazing at some tropical island. If he were really an operator the sight of Staten Island from the outside, would be about the only one which would cause him to smile.

The ads have their desired effect, as many graduates of radio schools pass examinations for government licenses; but what false impressions they have in their minds! Most new operators seem to have the idea that a radio operator is created to make possible the carrying on of commerce on the high seas, a thing that has been going on, Oh, so many, many years before Sparks was introduced to Mr. Commerce.

The radio schools are to blame for such propaganda, not only through their form of advertising but also through impressions given to students while attending school. The result is that many fellows who think they have certain egotistical claims to excellence go to sea, only to be immediately disillusioned and to do much harm to the profession.

A brand-new third mate, who had spent eight years in the forecabin and a brand-new Sparks, fresh from a four-month radio school, happened to receive their first jobs together on board the same vessel. The mate, being new as an officer and anxious to be successful, had opened a discussion of how he might best succeed in the long hard pull to the mastership of a vessel. Now Sparks, being the superman of the two and knowing so much more about the ship and shipping, having joined the vessel six hours before the mate, said, "Always be honest, conscientious, sober and attentive to duties. As for myself, I'm different, I'm the WIRELESS OPERATOR—The Hell with 'em!"

How many operators have gone aboard a ship and found everybody with a bad taste in their mouths towards radio operators? Many, to be sure. Realizing of course (according to the last operator) that all captains, mates and engineers are dumbbells, we are nevertheless put aboard to cooperate and help in all possible ways in the navigation of the vessel.

And don't believe that you are so important that a ship won't sail without the wireless operator. Some of the boys have been stung by this belief and have had to make earnest and pathetic pleas to the local American Consul in a faraway land.

As a radio operator, you may be a college man just going to sea for a vacation

(Continued on Page 36)

Write for this Discount Card NOW!



It will enable you to purchase the New and Improved

KNAPP "A" POWER KIT
at a liberal discount

The new Knapp "A" is the finest and most complete kit ever offered. It is the only "A" Power adaptable to Short Wave—Super Heterodyne and Television reception.

Take advantage of the wonderful offer today—write

David W. Knapp, Pres.

Knapp Electric, Inc.

Division of P. R. Mallory & Co., Inc.
Room 416, 350 Madison Ave., N. Y. C.

Tell them you saw it in RADIO

AN INVESTMENT THAT PAYS DIVIDENDS

An indicating instrument is an essential part of the equipment of every good radio receiver installation, since it aids in maintaining efficient operation, secures the best reception and fully protects the financial investment.

To advanced radio enthusiasts and those having professional connections with the industry, the selection of instruments is highly important. Unfailing reliability is the first consideration, since accuracy of measurement is a fundamental requisite of success in both research work and commercial activities, and pays the biggest dividends on the investment—whether of time or money.

Illustrated herewith are the Weston Portable A.C. and D.C. instruments which are extremely popular for general radio service and make ideal personal instruments.

Three-Range Instruments for A.C. and D.C. Operated Sets



The fine workmanship, excellent characteristics and dependable performance of these models—No. 528 A.C. and No. 489 D.C.—merit an unquestioned preference over all other makes. Moderate in price, too. Enclosed in beautifully finished bakelite cases—black for D.C. and mottled red and black for A.C. instruments. 750/250/10 volts (1000 ohms per volt resistance) for D.C. service, and 150/8/4 volts for A.C. testing.

Single and Double-Range Instruments

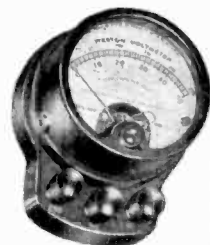

These same models, identical in size and appearance and enclosed in the same bakelite cases, are also furnished as D.C. double-range Voltmeters—(with either 1000 ohms per volt or 125 ohms per volt resistance) and as single and double-range Ammeters. For A.C. testing they are supplied as single-range Ammeters and Milliameters and double-range Voltmeters.

All instruments of the Weston Radio Line are completely described in Circular J—just off the press. Write for your copy.

WESTON ELECTRICAL INSTRUMENT CORPORATION
600 Frelinghuysen Ave.
NEWARK, N. J.

Pacific Coast Representatives

Graybar Electric Company, Inc.
84 Marion St.
Seattle, Wash.
J. H. Southard
San Francisco, Calif.

A. A. Barbera
Los Angeles, Calif.
Repair Service Laboratory
682 Mission St.
San Francisco, Calif.

WESTON RADIO INSTRUMENTS

New Admiralty Model NORDEN-HAUCK SHIELDED SUPER-10

FEATURES

10 tubes used. Five 222 screen grid R.F. amplifiers, 200A detector, two 240 Hi-Mu's and two 210 tubes in the power audio amplifier.
Extremely sensitive—long range.
Totally shielded.
Super-selective—10 Kc. separation.
Perfect quality of reproduction.
Indicating Meters on Panel.
Removable R.F. Transformers for all wavelengths up to 25,000 meters.
Electric or Battery operated.
Simple to operate—only two major tuning controls.
A laboratory precision Instrument built according to U. S. Navy Standards.

Complete attractive illustrated literature sent upon request. Full size genuine Blue Prints and constructional data \$2.00 Postpaid.

Write, telegraph or cable today

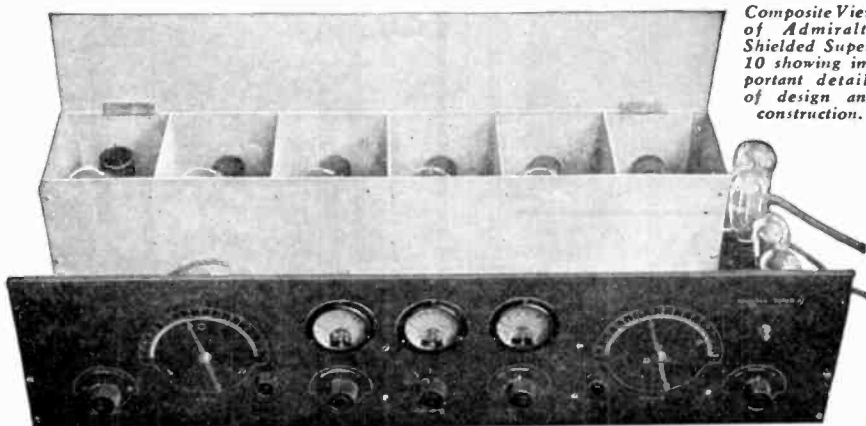

Composite View of Admiralty Shielded Super-10 showing important details of design and construction.

This great new Receiver is far in advance of competition. It is a powerful 10-tube model incorporating the most complete and up-to-date principles. Using the new screen grid tubes in the R.F. amplifier and push-pull audio system, make this new model the outstanding development in Receiver designs for years.

NORDEN-HAUCK, Inc., Engineers

Dept. R, Marine Bldg., Philadelphia, Pa.

CABLE—NORHAUCK

BUILDERS OF THE HIGHEST CLASS RADIO APPARATUS IN THE WORLD

New Birnbach Cord



Moisture-Proof Extension Cords

Birnbach Extension Cords permit the Loud Speaker to be moved to any room in the house. Attaches instantly. Install a Birnbach Cord and put an end to distortion so often due to badly insulated cords. Your neighborhood dealer has these sizes in stock: 10-20-30-40-50-100 foot lengths. Send for Catalog.

BIRNBACH RADIO CO.
254 W. 31st St. New York

NEW

THERMATROL Voltage Control



Protects AC Tubes From Burning Out In Electric Sets

AC Tubes for electric sets burn out easily and are expensive. Don't take a chance when you can protect all the tubes in your set and condensers in the power pack with a Thermatrol Voltage Control. Only \$1.75—less than half the cost of one tube, yet protects them all. If your dealer can't supply you, order one direct. Save your tubes.

The THERMATROL MFG. CO.
52 Willow St., Springfield, Mass.

JUST OUT! NEW LOG BOOK
25 CENTS Corrected to Nov. 11. All the New Allocations.
"RADIO," Pacific Bldg., San Francisco

350 PUSH-PULL AMPLIFIER

Capable of Tremendous Volume and Most Exquisite Tone

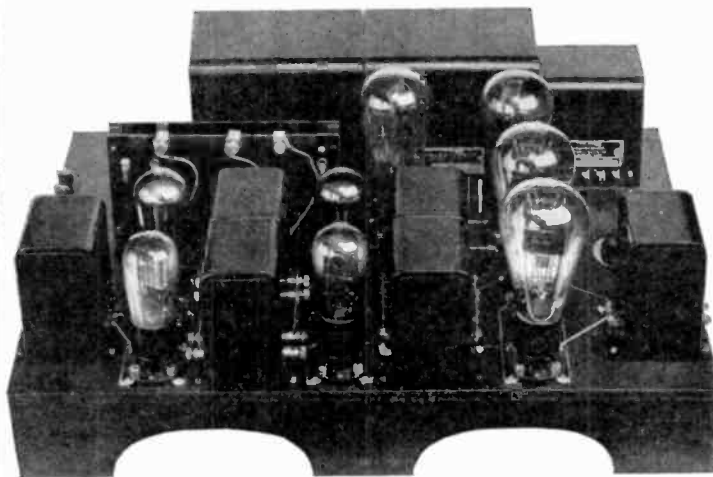

HERE is a deluxe power amplifier and "B" eliminator using General Radio apparatus of the finest kind to reproduce voice and music of majestic tonal qualities with volume sufficient to fill the largest auditorium. Ideal for outdoor demonstrations, theatres, dance halls and large homes. It is a custom-built amplifier. Accurately wired, balanced, tested and guaranteed in every respect. Push-Pull throughout in all three stages.

A.C. OPERATION THROUGHOUT

Complete A.C. operation without hum. Suitable for phonograph or radio use. Complete parts with instructions for assembly can be supplied or you can purchase the built-up and wired amplifier exactly as illustrated. We can also supply a smaller amplifier using a single "250" tube and the usual audio stages. Microphones, microphone amplifiers and Jensen Auditorium Loud Speakers for all requirements. Prices on request.

C. C. LANGEVIN Co., 274 Brannan St., San Francisco

Tell them you saw it in RADIO



Hear This
AC Electric
Power
Speaker
Radio!

Dynacone \$25

GEMBOX \$65

You will not be satisfied with your old set after you hear one of the new Crosley Radios. The new full toned power speaker Crosley sets are 1928's greatest radio achievement. Compare a Crosley set with any other and you will find it to be up-to-date—genuine neutrodyne, selective, sensitive, illuminated dial, completely shielded, volume without distortion and adaptability for installation in any type console cabinet.



Showbox \$80



Bandbox \$55



Musicone \$15



Bandbox Jr. \$35

**FREE TRIAL
IN YOUR
OWN HOME**

Crosley Dealers are authorized to home demonstrate any Crosley Receiver. This is the only way to buy radio. Visit your nearest dealer or write Dept. 19 for his name and address.

CROSLEY

The Crosley Radio Corporation
Powel Crosley, Jr., Pres. CINCINNATI, O.
Montana, Wyoming, Colorado, New Mexico
and West prices slightly higher
Prices of Crosley Radio Receivers do not include tubes



Console. Walnut finished cabinet. Dynamic or magnetic speaker. Size 26" x 40" x 16" deep. 6-tube standard Code No. PC-2829-RAC-6, and 7-tube "Push-Pull" Code No. PC-2829-RAC-7.

Private Label Radio Brings You Most Profit

The entire radio merchandising world knows the remedy for the disadvantages of a national fixed-price policy, for top-heavy inventories, burdensome contracts and insufficient mark-up. Private label radio!

Remember also that material and manufacture—not advertising—determine the quality, performance and salability of a receiver.

Premier Radio for Private Label gives you longer profits, absolute control of price in regard to local markets; you order out only what you need; you preserve your most valuable possession—your trade identity.

Premier Radio is the equal of any in performance, looks, quality and salability. Table and Console Models furnished standard in 6-tube and 7-tube Push-Pull. Also combination radio and phonograph with electric pick-up.

Chassis Specifications

All-metal chassis; rigid, strong, stays put. Unconditionally guaranteed. Apparatus 100% shielded. Licensed under U. S. Navy Patents and Hogan Patent No. 1,041,002.

Write for price and full details
No Obligation

PREMIER ELECTRIC COMPANY

Established 1905—Manufacturers Ever Since
3836 Ravenswood Avenue
CHICAGO, ILL.

WHO IS THE RADIO OPERATOR?

(Continued from Page 34)

and will return soon to finish your career. Or your dad, (through no fault of your own) may be a millionaire. But no matter what you are or think you are, to your fellow officers, you are just plain SPARKS.

The other officers aboard ship have attained their licenses and positions in most cases through many painful hard years in the fore-castle, engine room or on the bridge and they cannot be blamed if a little hasty in passing judgment on an operator for some gross breach of marine etiquette. Marine customs die the hardest of any in the world. Discipline and the whims and caprices of a new radio operator do not jibe on board any ship. Operators are unfortunate inasmuch that they do not go through the fore-castle, but immediately upon going to sea have the privilege of the salon. In many cases it is the young fellow's first job.

It is almost a shame to write this when it is a known fact that there are so many fine, capable and modest fellows serving as radio operators in the maritime service, but it is done so with the hope that all Spark's will strive for a better understanding of their fellow officers aboard ship.

SKEDS AND TRAFFIC NOTES

From Paul A. Girard, S. S. West Kedron:

HWE, Monrovia, Liberia, succeeded by RZC, and operated by the Firestone plantation for the local government and themselves. RZC communicates with surrounding provinces on about 34 and 600 meters CW. His 600 CW is hard to copy at times, but in the main it gets through static much better than Spark. RZC also communicates with U. S. A. (Akron, Ohio).

Most all towns of any size along the coast have an Army SW installation which will handle public traffic. As the landline in this country is very poor this SW traffic is increasing.

NAA comes in OK with his time ticks, but PX time is daylight here, and is unheard. No static is experienced on short waves.

GBR sends press on short waves at 8 a. m. G. C. T.

From Harry F. Washburn:

2XD, Tuckerton, N. J. (WSC). Stands watch from 2100 to 0500 GMT for ship calls on 36 meters except when occupied with tfe skeds. He also stands watch during the early morning hours and up until about 2 p.m. EST, for ship calls on 23 meters. Answers on 23.6, 1½ KW 500-cycle transmitter is used. QSJ same as for WSC.

GKT, Burnham Radio, England. Listens on 36 and answers on about 37. Mushy 500-cycle note. Tolls probably same as for GKU.

From Bill Breniman, KOZC:

KHK, Wahiawa, 22 miles from Honolulu, T. H., sends PX composed of items of local interest at 11 p. m. and 10 a. m. local time. This PX is broadcast on 2200 meters, free copy for all ships.

LAST MINUTE SPECIALS!

E210 BRADLEYSTATS, list \$4.00, fine A.C. Line Voltage Control.....	Our Price \$1.60 ea.
Genuine Black Bakelite Panels 3/16" thick, 38" x 43". Reg. Price \$29.00.....	" 8.75 ea.
U. S. ARMY Aeroplane Spark Transmitters, Gov. cost \$47 each.....	" 4.75 ea.
G. E. Kenotron Rectifying Tubes (type T.B.1).....	" 1.25 ea.
Eby A.C. Adapter Harness with Volume Control. For 6 tube Sets, list \$10.00.....	" 5.00 ea.
Gould Kathanode Unipower, Automatic Radio "A" Power (6 volt), list \$39.50.....	" 13.75 ea.

AMERICAN SALES CO., 19-21 WARREN ST., NEW YORK CITY

Before Buying

Any "A" Eliminators

Write me about the discount card which enables you to purchase the new and improved

Knapp "A" Power Kit
at a liberal discount.

The most complete "A" Power Kitever offered—Address for details of plan—

David W. Knapp, Pres.

Knapp Electric, Inc.

Room 416, 350 Madison Ave., New York City

SPINTITE WRENCHES FREE

With a one year subscription to "Radio" 3 Stevens Spintite wrenches for round nuts given free this month with a subscription to "RADIO." Send \$2.50, get "RADIO" for one year, and the wrenches also. We pay the postage. Only a few sets of these wrenches still on hand. *Hurry.*

Publishers of "RADIO"
Pacific Bldg. San Francisco

Gerald Best's SUPER BLUE PRINTS

The complete working plans in full size for building the new incomparable Gerald Best 115 Kilocycle superheterodyne with full instructions for building.

Per set. Postpaid anywhere in the U. S. Send remittance by cash, check or money order. Stamps also accepted. "RADIO," Pacific Bldg., San Francisco, California.

25c

Sparks!

Are you looking for a good position ashore as radio operator at a broadcasting station?

Are you qualified to operate such a station if the opportunity presents itself? Do you know what the duties of a control operator are at a broadcasting station? Are you familiar with the following terms and expressions used in broadcasting: Transmission Unit (TU), Line Pads, Equalizer, Frequency Modulation, Attenuation, etc., etc.?

If you want to qualify for a remunerative position ashore, the one essential study guide and reference book is

THE RADIO MANUAL

A Complete Course in
Radio Operation
In a Single Volume

A Handbook
for
Students
Amateurs
Operators
Inspectors
16 Chapters
Cover:



Elementary Electricity and Magnetism; Motors and Generators; Storage Batteries and Charging Circuits; The Vacuum Tube; Circuits Employed in Vacuum Tube Transmitters; Modulating Systems; Wavemeters; Piezo-Electric Oscillators; Wave Traps; Marine Vacuum Tube Transmitters; Radio Broadcasting Equipment; Arc Transmitters; Spark Transmitters; Commercial Radio Receivers; Radio Beacons and Direction Finders; Radio Laws and Regulations; Handling and Abstracting Traffic.

Prepared by Official
Examining Officer

The author, G. E. STERLING, is Radio Inspector and Examining Officer, Radio Division, U. S. Dept. of Commerce. The book has been edited in detail by ROBERT S. KRUSE, for five years Technical Editor of QST, the Magazine of the Radio Relay League. Many other experts assisted them.

New Information never before available such as a complete description of the Western Electric 5-Kilowatt Broadcasting Transmitter; description and circuit diagram of Western Electric Superheterodyne Radio Receiving Outfit type 6004-C; Navy Standard 2-Kilowatt Spark Transmitter; etc.; etc. Every detail up to the minute.

FREE EXAMINATION

"The Radio Manual" has just been published. Over 900 pages. Profusely illustrated. Bound in Flexible Fabrikoid. The coupon brings the volume for free examination. If you do not agree that it is the best Radio book you have seen, return it and owe nothing. If you keep it, send the price of \$6.00 within ten days.

Order on This Coupon

D. VAN NOSTRAND CO., INC.,
8 Warren St., New York

Send me THE RADIO MANUAL for examination. Within ten days after receipt I will either return the volume or send you \$6.00, the price in full.

(Radio 12-28)

Name

St. and No.

City and State

Now...4 or 6 Volts
with the
Improved

Knapp "A" POWER



Operates on 105 to 120 volts, 50 to 60 cycles.

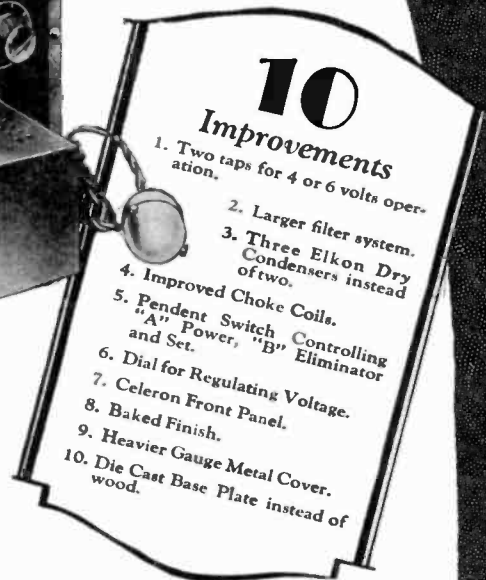

10 Improvements

1. Two taps for 4 or 6 volts operation.
2. Larger filter system.
3. Three Elkon Dry Condensers instead of two.
4. Improved Choke Coils.
5. Pendant Switch Controlling "A" Power, "B" Eliminator and Set.
6. Dial for Regulating Voltage.
7. Celeron Front Panel.
8. Baked Finish.
9. Heavier Gauge Metal Cover.
10. Die Cast Base Plate instead of wood.

The only "A" Power
Suitable for all Sets

— Irrespective of number of tubes — including
SuperHets, Short Wave and Television receivers

THE new Knapp "A" Power is designed for the most exacting service — super-hets, short wave and television receivers included. I knew that if it would perform satisfactorily with these receivers that there could be no question as to its efficiency on ordinary broadcast signals. The three Elkon dry condensers, the improved choke coils and the special Elkon dry rectifier make the difference between ordinary and Knapp performance.

No Change in Price

Even with these wonderful and costly improvements, there has been no advance in price—due to the tremendous volume going thru my plant. Remember that the Knapp is the fastest selling "A" Power on the market.



David W. Knapp, Pres.

KNAPP ELECTRIC, Inc.
—Division of P. R. Mallory & Co., Inc.—
350 Madison Ave., New York City

See your dealer today

Go to your dealer today. Most of the good ones carry the Knapp in stock. Do not accept a substitute—because only in the Knapp will you get full satisfaction as typified by the famous Knapp "A" Power. If your dealer cannot supply you send the coupon.

Mr. David W. Knapp, Pres.,
Knapp Electric, Inc., Dept. K-11
350 Madison Ave., N. Y. C.
Send me complete information on the Knapp
"A" Power.



AMERTRAN

Push-Pull Power Stage for Dynamic Speakers

For best results, every dynamic type speaker should be preceded by a push-pull amplifier. This is particularly true because they reproduce frequencies as low as 30 cycles and the attendant hum from raw AC on the filaments of power tubes is greatly pronounced unless filtered out by a push-pull amplifier. The AmerTran completely wired push-pull power stage has been specially designed for dynamic speakers. Consists of type 151 input and output transformers (200 for working out of 210 type tubes or 362 for 171 type tubes). Completely wired with sockets and resistances. Also available for cone type speakers and for both 210 and 171 tubes.

Licensed under Patents owned or controlled by R. C. A. and may be bought with tubes

Price complete (without tubes) \$36.00.
(slightly higher west of Rocky Mountains)

Write us for look-up of this remarkable instrument.

AMERICAN TRANSFORMER COMPANY
Transformer Builders for more than 28 Years
275 Emmet Street, Newark, N. J.

There is no substitute for PERFORMANCE

*Alibis don't go—excuses are futile—
performance is the thing.*

Orders and reorders from the most representative concerns in the country constitute concrete evidence that **CARDWELL CONDENSERS** are right.

Names synonymous with prestige and sterling worth, representing the greater part of the astonishing progress of the past quarter century in radio and other electrical installations of all descriptions, will be found on our list of customers.

Where performance counts and not pennies. Engineers and manufacturers stake their reputations on the confidence they have in **CARDWELL CONDENSERS** and their ability to "Stand the Gaff" and come through.

CARDWELL CONDENSERS

—for all purposes—

Variable ✓ Fixed ✓ Transmitting
Receiving

"The Standard of Comparison"
[Literature Upon Request]

The Allen D. Cardwell Mfg. Corp.
81 Prospect Street BROOKLYN, N. Y.

KROBLAK RESISTANCES

For Eliminators, Power Amplifiers, Electric Sets and Experimental Television Work.

Write for circular

C. E. Mountford, 30 Sullivan St., N. Y.

BROADCASTING IN PARIS

(Continued from Page 13)

Fortunately, however, the two government stations are so bad that there is no possibility of the law being enforced against the protests that rage when there is any suggestion of doing so.

Advertisement by radio is also dealt with in the same law, and entirely prohibited; but as the official stations are the worst offenders in this respect, it is not surprising that the others follow suit. And it is direct advertising at that, usually one advertisement between each musical item and the next, or interspersed with the news bulletins. As a rule these advertisements are boring in the extreme; there are occasional exceptions, as for instance, the maker of underwear who has hit on the idea of repeating the official weather forecast at intervals through the day, adding appropriate remarks either on the desirability of not trusting the forecast too fully, and therefore of continuing to wear his products (when the forecast is optimistic) or of buying more of them (when, as is usually the case, it predicts rain and cold).

There is also a certain amount of indirect advertising, where the manufacturer pays for the program and the fact is duly mentioned before each item, but it is relatively rare. The practice of the manufacturer providing the entertainment and buying time is practically unknown.

Thanks to the poor quality of the transmissions, the average receiving set is intolerable from a musical point of view. It is no exaggeration to say that 90% of the sets have no provision for C batteries, and the average audio transformer is a miserable little skeleton that looks as if it had been designed for a portable set to be used on a walking tour. There is no doubt that a good American set would carry all before it, if it could be sold at a price to compete with the local products, and if it could cover the range of wavelengths necessary (up to 2650 meters).

The music is good (except for the jazz, which is ghastly—French bands seem incapable of getting the jazz spirit, and apparently only the worst of them play for the radio, anyway). For example, Radio Paris always gives one operetta or light opera a week, very well done; plus an average of two classical string quartettes or other chamber music items a day; plus as a rule at least one big item a week. By "big" I mean such things as the Bach B Minor Mass, or Honegger's "King David," with himself conducting, or a Beethoven concert with the Ninth Symphony.

But perhaps the best indication of the Frenchman's own point of view is to hear the customers at a big radio store—the one stock question asked is "Will it get Daventry?" If not, no sale.

Tell them you saw it in RADIO

Potter Condensers



STAND guard day and night over the operation of numerous radio receivers of the leading manufacturers.

The selection of Potter Condensers by the engineers was made after careful tests under operating conditions.

He who purchases a set or power amplifier with Potter Condensers knows that the balance of the equipment can be depended upon for the same high standard of performance.

T-2900 Condenser \$20.00

T-2950 Condenser 22.50

The POTTER COMPANY

North Chicago, Ill.

Pacific Coast Office

905 Mission St., San Francisco, Calif.

**SHERMAN
SQUARE
HOTEL**
70TH ST.
&
B'WAY
NY

CONVENIENT HOMELIKE

QUIET COMFORTABLE

EXCELLENT FOOD
AT MODERATE
PRICES

COURTEOUS
SERVICE

SINGLE ROOM \$2.50
AND BATH

FOR TWO \$4.00

REASONABLE RATES
WIRE
AT OUR
EXPENSE

SET BUILDERS

write for

Discount Card

Enabling you to purchase the new and Improved Knapp "A" Power Kit at big discount—Write for full particulars.

DAVID W. KNAPP, Pres.

Knapp Electric, Inc.

Division of P. R. Mallory & Co. Inc.
Room 416, 350 Madison Ave., N. Y. C.

GET MY DISCOUNT CARD!

Before buying a **KNAPP "A" POWER KIT** Absolutely dry—Magically silent—the finest "A" Power adaptable to Short Wave, Super-Heterodyne and Television reception.

WITH THE 10 NEW IMPROVEMENTS Write me today for details of this money saving plan and get your discount card. Address

DAVID W. KNAPP, Pres.
Knapp Electric, Inc.
Division of P. R. Mallory & Co., Inc.
Room 416, 350 Madison Ave., N. Y. C.



Professional Set Builders and Dealers!

The latest developments of the 1929 season are fully described in our **NEW FREE Catalog**. Lowest prices on all nationally advertised kits, sets, accessories, cabinets, etc. Get the **BEST in RADIO**—at the **BIGGEST SAVING**. Complete stock carried. No shipping delays. Write for **Catalog TODAY**.

TELEVISION—We have complete information which will prove interesting to **SET BUILDERS**.

WALTER ROWAN CO.
833 Washington Blvd., Dept. 101
CHICAGO, ILL.

Send for New Radio Book—It's Free!

New hook-ups. This book shows how to make short-wave receivers and short-wave adapters. How to use the new screen grid tube in D. C. and A. C. circuits. How to build power amplifiers, ABC eliminators. Up-to-the-minute information on all new radio developments. It's free. Send for copy today.

KARAS ELECTRIC COMPANY
4031M North Rockwell Street, Chicago, Ill.
Portland, Oregon, 53 4th St.
San Francisco, 585 Mission St.
Los Angeles, 324 N. San Pedro

Name.....
St. and No.....
City and State.....

4031L2

CUSTOM SET BUILDERS

Browning-Drake has an interesting and unusual proposition. Take advantage of the fact that more Browning-Drakes are built than any other. Write today.

BROWNING-DRAKE CORP.
CAMBRIDGE, MASS.

\$1.00 Brings you the next 6 issues of "RADIO"

SHORT-WAVE SUPER

(Continued from Page 15)

on 20 turns, then wind back over this 19 turns, then 18 and so on for seven layers. Each layer has one less turn than the one preceding. When one group is finished bring the wire back down to the tube and start another. If the turns have a tendency to slip, put a little collodion around the edges as each layer is finished.) This type of winding was quite popular a few years ago, for coils used in the reception of long waves. Fig. 4 gives the details of the transformers.

To obtain a large gain per stage, capacity coupling between the primary and secondary must be low. Therefore the primaries should be wound with small wire and concentrated in as small a space as possible.

In this super the primaries are wound on wooden disks $\frac{3}{8}$ in. thick that fit snugly inside of the bakelite tubing at the filament end of the secondaries. Three are required. Cut these so that they make a real tight fit, as they shrink somewhat after "boiling" in paraffine. Cut a slot around each disk about $\frac{1}{16}$ in. deep with a hacksaw. Wind 175 turns of No. 36 enamel wire in each slot, in the same direction as the secondaries. If 201A's are to be used in the i.f. and second detector, wind only 100 turns on the disks as the internal capacity between the elements of a 201A is higher than a 199 tube.

After winding, boil the disks in paraffine to exclude all moisture. While doing this make sure that the paraffine is not hot enough to smoke. It takes about a half-hour for this job. After the disks are boiled and thoroughly dry, drill two holes in each and insert bolts $\frac{3}{4}$ in. long. Place a soldering lug under the head of the bolts and solder the primary leads to these. Flexible wire may then be fastened to the bolts and connected to binding posts at the end of the tube.

The tickler in the plate circuit of the second detector is made like the primaries but has only 100 turns of No. 36 enamel wire. This coil is placed inside the form near the grid end of the secondary of the last transformer. Its use permits the reception of continuous wave signals. A switch is provided to short circuit this coil when phone is desired. Different tubes require different size ticklers. If the set howls when the switch is open remove some of the turns. If the tube refuses to oscillate (after reversing the tickler leads) add more turns; 100 however, will usually be about right.

A "losser" or potentiometer of 200 ohms resistance is placed across the A battery and the grid returns of the two i.f. tubes connected to the lever for controlling oscillations. It is possible to do away with this lossy by moving the primaries away from the secondaries until oscillations stop. It takes a lot of ex-



AERO METROPOLITAN

This new Aero Kit—complete down to the last detail—typifies a new standard of value in radio receivers. The **METROPOLITAN** combines advanced engineering principles, exquisite cabinet design and low price. Employing only four tubes, this set is so selective that it has already won wide favor in congested districts—so sensitive that it offers true long distance reception—so true in tone that it is the marvel of all who hear it. The metal cabinet housing this receiver is beautifully finished in two tones and highlighted with silver. It blends harmoniously with the finest of home furnishings.

You Can Assemble It In One Evening

No expense has been spared to make Aero Kits the finest that money can buy. They include everything you need to assemble the receiver—even wire, soldering lugs and wood screws—so that nothing more need be purchased. Panels are drilled, insuring proper placement of parts, and full size pictorial wiring diagrams eliminate mistakes in wiring. Even if you have never assembled a set before, you will find it an easy, pleasant task to wire up the **METROPOLITAN**.

- Complete Kit, including cabinet.....\$58.00
 - Complete Kit, without cabinet but including walnut finish Micarta 7"x18" panel, drilled and engraved 53.00
- May be had for A.C., D.C. or Shield Grid Tubes. Specify which you intend to use.

A postcard request brings two valuable booklets introducing the new 1929 line of Aero Kits and describing the 64-page Aero Green Book for 1929. Send to

AERO PRODUCTS
INCORPORATED
Dept. 598 4611 E. Ravenswood Ave.
CHICAGO, ILL.

Tell them you saw it in RADIO

This 7 Second Test

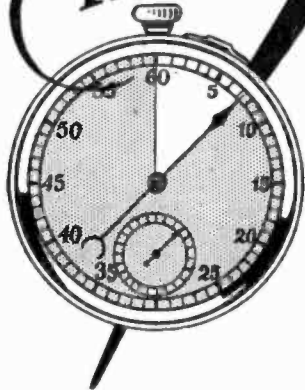

Improves Your Radio for ALL TIME

127 DETECTOR

Acts in 7 seconds . . . immune to line surge . . . established record for life, over 5,000 hours.



126 H AMPLIFIER

Minimizes hum . . . increases volume . . . betters reception.



071 H POWER AMPLIFIER

Improves reception . . . average life over 2,000 hours . . . delivers undistorted volume, minus hum.



PUT an Arcturus heater-type A-C Long Life Tube in every socket of your set . . . turn it on . . . and in 7 seconds you experience a revelation in radio reception! Your set is improved for all time.

You will marvel at its new tone . . . its quick action . . . its trouble-free performance . . . and its exceptionally long life when equipped with these new Arcturus "heater-type" Tubes.

The only complete line of heater-type tubes in the world. The 127 Detector acts in 7 seconds . . . the 071H Power Amplifier greatly improves reception . . . the 126H is the most efficient Amplifier made. The trend in set construction is towards "heater-type" tubes.

Your set can be the latest development in radio. Re-tube with Arcturus heater-type Tubes. Get a complete set from your dealer.

WEST COAST DISTRIBUTORS

UNIVERSAL AGENCIES
905 Mission Street
San Francisco, Cal.

WESTERN SALES & SERVICE CO.
W. 1817 Augusta Ave.
Spokane, Wash.

ARCTURUS A-C LONG LIFE TUBES

CONTROL

Prevent the ups and downs of your tubes. Install AMPERITES—the filament control that keeps voltage constant. AMPERITES insure long tube life and better reception. A type for every tube—battery or A. C.

\$1.10 with mounting (in U.S.A.)

Radiall Company
50 FRANKLIN ST., NEW YORK



FREE New "Ampelite Blue Book"—brim full of useful radio pointers and circuit diagrams. Write Dept. R. 12

AMPERITE
REG. U.S. PAT. OFF.
The "SELF-ADJUSTING" Rheostat

SET BUILDERS

Get this Book



Barawik, the first and oldest radio specialty house, offers you unusual service this year. Bigger stocks, quicker shipments, lower prices. Deal with an old established, reliable house. Get honest goods, honest service, honest prices. Barawik service makes you more money. Send now for big new Catalog showing lowest wholesale prices.

BARAWIK CO. 1812 Canal Sta., CHICAGO, U. S. A.

Mail This Coupon Now for Free Radio Guide

Name _____

Address _____

perimenting to do this right, so is not recommended.

An r.f. choke is necessary in the plate circuit of the second detector to keep the r.f. out of the phones or audio amplifier. Eight hundred turns of No. 36 enamel wire wound on a common thread spool or any other form about 3/4-in. in diameter will do very well. The grid condenser has a capacity of .0005 mfd. The grid leak is of 2 megohms resistance and is connected between the grid and positive side of the filament. If a condenser larger than .002 mfd. be used as a bypass across the output, the quality (of phone or music) will not be very good.

One 30-ohm rheostat is used to control the filaments of the two i.f. and second detector, and one for the oscillator and first detector. A plate voltage of 45 is sufficient for all tubes.

No audio amplifier is built into this set, so the reader may use his own ideas if one is desired.

The parts are mounted on a bakelite panel 7 by 21 in., and wooden baseboard which is about 1 in. shorter than the panel, allowing the set to be fitted into a cabinet if desired. Two metal brackets hold the baseboard to the panel about 2 1/2 in. above the bottom, allowing the bypass condensers, r.f. chokes and the second detector grid condenser and leak to be placed underneath. The controls showing on the front panel are oscillator and first detector tuning condensers, filament rheostats, filament switch, tickler switch and potentiometer. In this set the potentiometer was mounted under the sub-panel as there was no room on the panel. It was set just below the oscillating point of the tubes and then left alone. However, it is better to mount it within easy reach.

The first detector and component parts are at the extreme right with the oscillator at the left. The i.f. amplifier is then mounted between these. See Fig. 5 for layout of the parts. The i.f. transformers are placed at right angles to each other with the tube sockets so arranged that the plate and grid leads are as short as possible.

The filament and B battery wires are all run under the sub-panel and bunched together. It is a good plan to do the wiring in steps. First run all of the A battery wires to the sockets, filament switch and rheostats. Then completely wire the first detector and oscillator. Next wire the grid circuits of the i.f. amplifier and second detector and last the plate circuits of this section. The bypass condensers, under the sub-panel, may then be connected. Where the wires are bunched together, tie with string at intervals of about 1 in. Feedback is partly eliminated by bunching these wires.

The terminal strip to the left of the second detector socket is for connecting to the phones or audio unit. The one

to the rear of the first detector contains six posts, two for the *A* battery, two for the *B* battery and two for antenna and ground. The *A* and *B* negative is grounded, helping to eliminate hand capacity effects especially on the shorter waves.

After the super is completely wired, it is a good idea to see if the frequency changer is working. Place a pair of headphones in the *B* positive lead going to the first detector, light the filaments of the first detector and oscillator. Set the detector condenser at about the middle of the scale and vary the oscillator condenser. A point should be found where a hissing noise is heard. This indicates that this part of the circuit is operating properly. Now connect the phones to the output binding posts and light the filaments of all the tubes. Short circuit the tickler by closing the switch. If all of the transformers are in resonance (they should be if all are built exactly alike) strong oscillations will be noticed. Turn the potentiometer towards the *A* positive connection until the oscillations are suppressed. The point for greatest signal strength is just below the oscillating condition. However, for the reception of phone or short wave broadcasts, the quality will not be very good so regeneration will have to be decreased. The best place to set the potentiometer will depend upon the quality desired. Of course, distortion is not important for code work. In this case set the potentiometer just below the oscillating point and open the tickler switch. This causes the second detector to oscillate and produce beats with the received signal after it is passed through the i.f. amplifier.

An antenna with a total length of about 50 ft. may be used with fine results. The use of a long aerial with a super broadens the tuning considerably. Better selectivity may be had by using a counterpoise instead of a ground. This may well be about 30 or 40 ft. of almost any kind of wire run in the cellar or around the baseboard.

Slightly louder signals may be had, especially in the 80 and 160-meter bands, by connecting a loading coil in the antenna lead. This coil should consist of 100 turns of No. 28 enamel wire on a tube 2½ in. long by 2½ in. in diameter, tapped at 0, 3, 6, 10, 15, 25, 40, 55, 70 and 100 turns. There is not space enough on the panel for this coil, so it may be built into a small box with a hard rubber or bakelite panel on which is mounted the rotary switch to change the number of turns.

If the set does not tune sharp enough for the builder, remove 75 turns from the primary of the first i.f. transformer and shunt it with a .0005 mfd. fixed condenser. Moving the primary away from the secondary will also help to sharpen up the tuning.

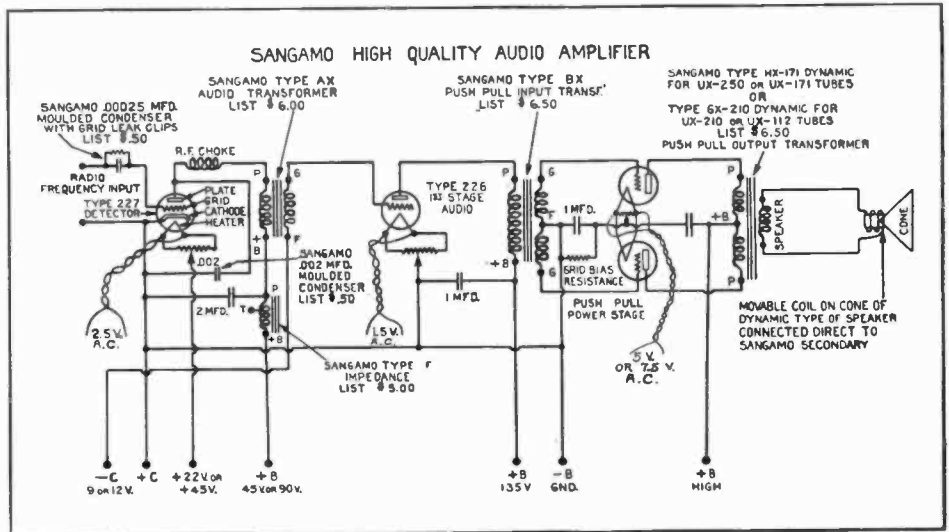

Build this modern amplifier at Low Cost!

Now! Sangamo Transformers at a new low price. And push-pull transformers to match new power tubes and dynamic loud speakers.

A small expenditure and you can have one of these modern amplifiers with plenty of capacity to handle the low notes. Nothing equals the full toned beauty of an amplifier built according to the diagram shown above. Write for descriptive circulars.



SPRINGFIELD,
ILLINOIS

SANGAMO
ELECTRIC COMPANY

Pacific Coast Offices:
1061 Howard St.
SAN FRANCISCO
750 Subway
Terminal Bldg.
LOS ANGELES



Cord Type
Standard Modu
Plug, \$2.50

The Art of Tuning--Is More Than Just Turning a Dial

Mere reception of a radio signal is not enough. It has ceased to be, "How many stations did you get?" The thing of importance today is "How well did you get them?"

There are two major operations in tuning a set: locating the station—and *modulating* it to obtain the best quality of tone.

The Centralab Modu Plug is the perfect volume and modulation control. With it, all the true beauty of tone and naturalness of speech reproduction can be obtained.

It is attached to any set in a moment without additional wiring or complicated connections. Equally as adaptable for volume control on phonograph pick-ups and speakers remote from the set.

An interesting book full of picture and wiring diagrams showing the use of Centralab Volume Controls and Resistors is yours for the asking.

26 Keefe
Avenue

Centralab
CENTRAL RADIO LABORATORIES

Milwaukee,
Wisconsin

Tell them you saw it in RADIO

41

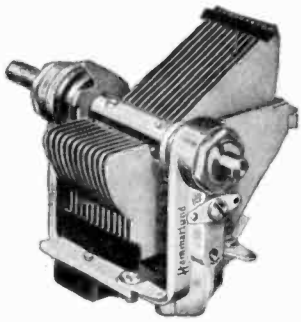

Is This Your Ideal Radio Condenser?

If So, the World's Foremost Radio Engineers Agree with You

Soldered brass plates with tie-bars; warpless aluminum alloy frame; ball bearings; bronze clock-spring pigtail; full-floating, removable rotor shaft permits direct tandem coupling to other condensers. Made in all standard capacities and accurately matched.

If Your Dealer Can't Supply You, Write Direct to Us

HAMMARLUND MFG. CO.
424-438 W. 33rd St. New York

For Better Radio
Hammarlund
PRECISION
PRODUCTS



TRUE TONAL VALUES

de Forest
AUDIONS

FOR those who appreciate better radio reception, the new perfected De Forest Audions—the latest achievement of Dr. Lee De Forest—assure the true tonal values of reproduction which add so much to radio enjoyment.

Sold by leading dealers everywhere

DE FOREST RADIO CO.
Jersey City, New Jersey

DE FOREST
AUDIONS



VOLUME CONTROL

(Continued from Page 19)

the last r.f. stage and the detector will generally give the most complete control of volume and cut down the r.f. hiss more if three or more stages are used. It may mean that the last or even next to the last r.f. amplifier is overloaded to such an extent that modulation or detection may occur in this stage with possibilities of audio distortion. This depends on whether or not the set is used very near a powerful local broadcasting station.

Most of the a.c. receivers will have satisfactory volume control on local stations if an antenna of not over 20 or 30 feet in length is used. A longer antenna may be used for distance reception, or if one is available, it may be used for local reception by cutting a .0001 or .00005 mfd. fixed condenser in series with it.

For a really satisfactory volume control on receivers using a.c. tubes, the control should affect more than one r.f. circuit, especially if the receiver is sensitive for weak signals. There is no reason why two or more variable resistances cannot be ganged on one knob so that two or more circuits will be affected. Fig. 2 (c) could be used for this arrangement for two succeeding stages such as aerial and 1st r.f. plate circuit. If the resistances were separated on an extension shaft so as to eliminate capacity coupling, one could be used at each end of the r.f. amplifier.

There are other methods of volume control such as having a copper or brass tube slide over one of the r.f. transformer primaries. This method along with any others which vary the primary coupling, are likely to throw the associated tuned circuit out of line, preventing single control. If single control is still maintained, it is generally at the sacrifice of selectivity at either the higher or lower wavelengths.

for DX RESULTS

you must have maximum signal pick-up. Don't depend on skimpy antenna. Don't be discouraged by "dead spots." Just use a CLAROSTAT ANTENNA PLUG, with the new type brass-plate and mica blocking condenser and 8-foot connecting cord. Neat, compact, safe and works anywhere.

Only \$1.50

Also, use proper grid leak value—from 2 megohms or less for "locals" to megohms for DX. The GRID LEAK CLAROSTAT provides precise values at all times.

And be sure you have correct B and C voltages. Several types of Clarostat will attend to that.

WRITE for literature on how to improve your radio results.

CLAROSTAT MFG. CO.
286 N. 6th Street Brooklyn, N. Y.

CLAROSTAT
REG. U. S. PAT. OFF.

Tell them you saw it in RADIO

Send For WESTERN RADIO New 1929 Catalog

Dealers and Set Builders

THE NEW 1929 Catalog is crammed full of the FINEST, NEWEST, Nationally known A.C. sets, consoles, cabinets, dynamic speakers, kits, eliminators and accessories at LOWEST PRICES. Largest stock of radio parts. Prompt delivery.

Write for our FREE catalog.
Western Radio Mfg. Co.
128 W. Lake St., Dept. R-11
CHICAGO

FREE



The Big
Friendly
Radio House

Newest Radio Hook-Ups—FREE

Send now for the newest radio hook-up book. Shows how easy it is to build remarkable new A. C. and D. C. receivers of longest range, greatest volume, purest, clearest tone and super-selective. Also shows how to make short-wave receivers and adapters, how to use new screen grid tube in A. C. and D. C. circuits, how to build power amplifiers and ABC eliminators. Latest information on all new radio wrinkles. Send for free copy now.

KARAS ELECTRIC COMPANY
4031M North Rockwell Street, Chicago, Ill.
Portland, Oregon, 53 4th St.
San Francisco, 585 Mission St.
Los Angeles, 324 N. San Pedro

Name.....
St. and No.....
City and State.....

4031L1

TELEVISION

although still in an experimental stage, has now advanced sufficiently to enable amateurs to build outfits that will give edifying results.

Write today for our price list of television apparatus.

Photo Electric Devices, Inc.
594 Fifth Ave. Brooklyn, N. Y.

Newest Information TO SET BUILDERS



Elections, football games, big National events will boost radio business this year. Set builders will reap a rich harvest. Barawik service will make you money. Everything in A-C sets, parts, supplies. World's largest radio stocks on hand. Orders shipped same day. Lowest rock-bottom wholesale prices.

Mail coupon for free Radio Catalog now
1812 Canal St.,
BARAWIK CO. CHICAGO, U. S. A.

Mail this coupon for Free Radio Guide

Name.....
Address.....

POWERIZER

REG. U. S. PAT. OFF.

SALES AND SERVICE STATIONS HAVE NO COMPETITION THIS YEAR!



Complete A-B-C Supply for A.C. tubes 226, 227, 171

While the ordinary dealer is trying his darndest to sell A.C. Electric Sets, POWERIZER SALES AND SERVICE STATIONS are allowing 100% trade-in value on the battery set on which the owner is already sold.

If you have the equipment and the ability, write in for the Powerizer Sales and Service Station proposition.

There are nearly six million battery sets from Maine to California—Conversion of battery sets and Power Amplifier installations will be *the* thing this year. Write for Bulletin P. R. 1022.

Radio Receptor Co., Inc.
106 Seventh Avenue, New York

Licensed by Radio Corporation of America and Associated Companies

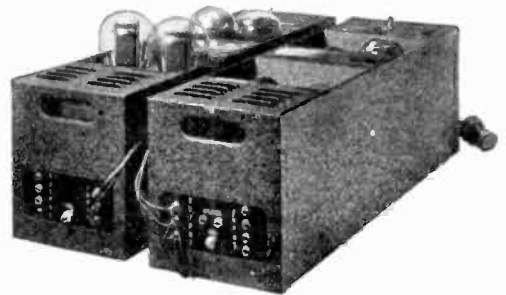

The Most Powerful 3-Stage Push-Pull Audio-Amplifier

X-L LINK

The Only Unit That Completely Links the Radio Receiver to the Light Socket

List Price
\$5.75



The new X-L Link makes possible the operation of a radio receiver entirely from one wire leading to the light socket, eliminating all other connections to the set whatsoever, and protects the tubes and parts of the set from injury.

It combines the following:

Antenna and Ground
(Using the shielded light wires; increases selectivity and reduces all types of interference)

Line Voltage Regulation
(Protects tubes and set from line voltage surges and prolongs life of tubes indefinitely)

Double Socket Outlet
(For set and dynamic speaker, or power units if used; switch controls dynamic speaker)

Complete Fusing
(Eliminates fire hazard and protects delicate instruments of set from burn-out)

Control Switch
(Exclusive feature. Turns dynamic speaker on and off and controls set if power units are used.)

Made with buffed silver finish and brown bakelite trim. Beautiful in appearance and performance. Unqualifiedly guaranteed by the makers of X-L Vario Denser.

X-L RADIO LABORATORIES

Department J 1224 BELMONT AVENUE, CHICAGO

AEROVOX

BUILT BETTER
CONDENSERS AND RESISTORS



PYROHM
VITREOUS ENAMELLED
RESISTORS

are made of the finest grade of resistance wire, wound on a refractory tube and protected by a vitreous enamel which prevents damage from moisture, oxidation and mechanical injury.

They meet with ease, the most rigorous tests imposed by modern heavy duty power equipment.

"The Research Worker"

is a free monthly publication that will keep you abreast of the latest developments in radio. Your name will be put on the mailing list free of charge on request.

The Complete
AEROVOX LINE
Includes

CONDENSERS

Filter Blocks
Buffer Blocks
Socket Power
High Voltage
Transmitting
Bypass
"A" Power
Bakelite Moulded Mica
Condensers
Interference Filters

RESISTORS

Pyrohm Heavy Duty
Edison Base Pyrohms
Tapped Pyrohms
Wire Wound Units
Grid Suppressors
Center-Tapped Units
Non-Inductive Lavite
Grid Leaks
Resistorformer Kits
Resistor Mountings

A Complete Catalog
with illustrations and detailed
descriptions may be obtained
free of charge on request.

AEROVOX WIRELESS CORP.
70 WASHINGTON ST.
BROOKLYN, N.Y.

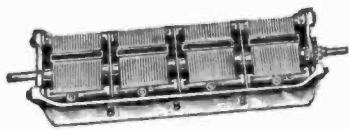

BATH TUB CONDENSERS

Now comes the Amsco "Bath-Tub" type Condenser. This new Amsco feature saves time in assembling, saves space, and assures greater rigidity and finer accuracy in single control tuning. It has been adopted by the largest manufacturers of sets and kits and is specified in all the leading circuits.

These new Amsco "Bath-Tub" type condensers can be had in double, triple and quadruple combinations.

If your dealer cannot supply you, write us for complete descriptive literature and prices.

AMSCO PRODUCTS

Broome & Lafayette Sts.
NEW YORK, N. Y.

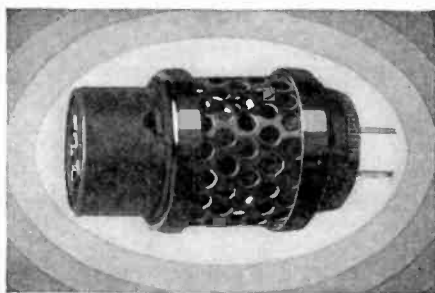
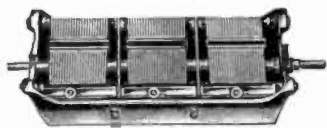

\$2.00 Insures Your A.C. Tubes

The Vitrohm 507-109 Unit costs \$2.00. Installed on your radio set, it lengthens a. c. tube life by automatically lowering filament voltage.

Attached in a moment—Nothing combustible—Nothing to wear out—Does not get excessively hot.

It consists of a Vitrohm Resistor mounted within a perforated metal cage, a plug, and a receptacle.

Write for free information on this and other Ward Leonard Radio Products.

WARD LEONARD MOUNT
ELECTRIC CO. VERNON
NEW YORK

WLW'S 50,000-WATT TRANSMITTER

(Continued from Page 11)

maintained by piezo crystals installed in duplicate in thermo-controlled compartments in which the temperature varies less than .1 degree.

As shown in the picture of the control room, the amplifying and tuning units are at the left and the rectifying unit is at the right. Each unit is enclosed in an electrically interlocked cage so that the opening of any door automatically shuts down the transmitter.

As the tubes are water-cooled, the water is circulated through cooling radiators upon which is blown cool air drawn from the outside by five immense fans. The hot air partially warms the building in winter and is carried in a stack through the roof in summer.

The short-wave transmitter W8XAL is installed in a separate room in the building. This also broadcasts the regular WLW programs.

The towers are also to be utilized as airplane beacons on the line between Cincinnati and Columbus.

LIGHTNING STRIKES AERIAL ON HOME

By EDWARD P. TALBOT

Whether an aerial protects a house from lightning or increases the risk of being struck is still an undecided question. Examples of direct hits are rare. A bolt which struck an aerial on a residence in El Paso, Texas, during a storm in July offers evidence on both sides of the argument.

The antenna was of the umbrella type, comprising four wires running from a central pipe mast to the four corners of the roof of a one-story brick bungalow. The lead-in came down the side of the house from one of the four wires and was connected to an air-gap type lightning arrestor grounded to an iron rod.

Inspection showed that the discharge apparently struck on or near the central mast and followed down the two wires extending to the rear corners of the house. These wires were anchored to a wooden sleeping porch, and the lightning made a splintered hole at each fastening, passed inside the porch, and jumped to both light and telephone wires which were about three feet distant.

The telephone bell-box was badly damaged, and the lightning arrestor in that circuit burned out, while the lightning system was deranged so that an engineer was required to find the trouble.

The aerial wires were burned or broken off, the insulators blackened, and the arrestor destroyed. The receiver, tubes, batteries and speaker were strangely left unhurt and performed as usual when the aerial was replaced.

POWER TRANSFORMERS for the UX 250 Power Tube



TYPE 565-A TRANSFORMER
(200 watts)

The General Radio Type 565 Power Transformers consist of two models for both half and full-wave rectification utilizing the 281 type of rectifier tube. The Type 565-A Half-Wave Transformer illustrated consists of one 600-volt secondary, two secondaries of 7.5 volts and one of 2.5 volts. It is designed for 105 to 125-volt, 50 to 60-cycle lines.

Bulletin No. 931 will be sent on request.



General Radio Co.

30 State Street, Cambridge, Mass.

274 Brannan Street

San Francisco, Calif.

PRICE - - - \$13.50

PROFESSOR HERMANN SCHNITZEL

Of the University of Cincinnati, O-ho-ho

has written a booklet containing 21 short radio lectures which have been broadcast from many stations. 50 cents per copy, postpaid. You will enjoy this book.

For sale by "RADIO," Pacific Building, San Francisco

THE R. F. CHOKE

(Continued from Page 20)

across them. The curves are shown in Fig. 6. Note that all the impedances are much lower. Choke No. 1 is still the best of the group though the peak has changed

sufficiently by the addition of the 15 mmf. condenser to bring it outside the 200-550 wave band. The characteristics of choke No. 4 have been changed so that its peak, which formerly was somewhat below 200 meters, is now about 250 meters.

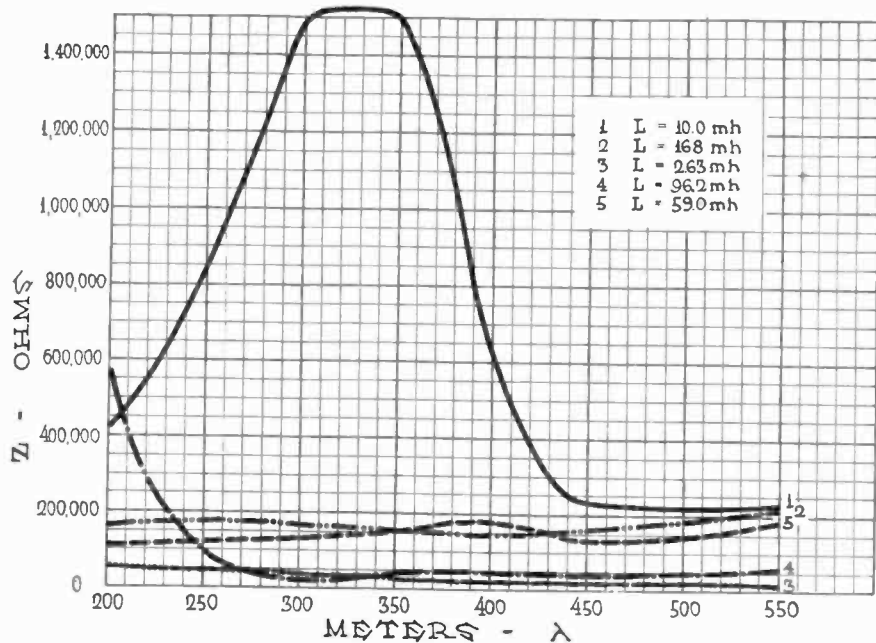

Fig. 5. Impedance of Chokes without Shunt Capacity

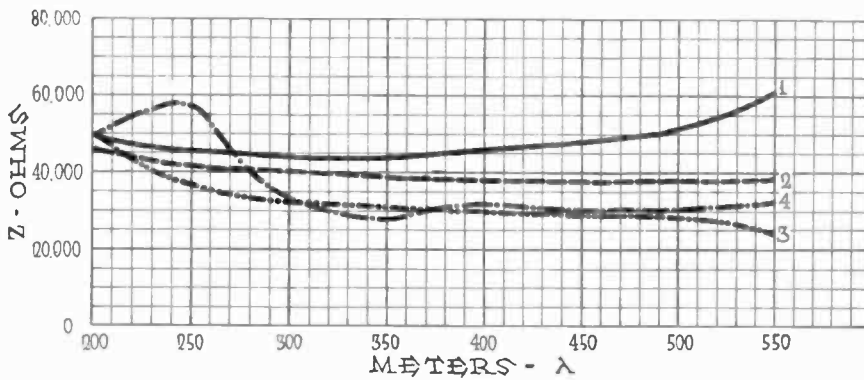

Fig. 6. Impedance of Chokes with 15 mmfd. Shunt

A REAL XMAS OFFER!!

UNI-RECTRON POWER AMPLIFIER

(Ideal for use with Dynamic Speakers)

Model AP-935

As the Uni-Rectron stands it is a super power amplifier, which can be used in connection with any radio set and loud speaker. Binding posts are provided for input to the Uni-Rectron and output to the speaker.

Requires no batteries for its operation. It obtains its power from the 110 volt, 60 cycle alternating current lighting circuit of your house.



List Price \$88.50
(without tubes)

SPECIAL \$19.75 Ea.

Every one new and packed in original factory carton

The UX-210 super power amplifying tube and the UX-216B or 281 rectifying tube are used with this amplifier, which cannot overload. From the faintest whisper to the loudest crash of sound—R. C. A. Uni-Rectron amplifies each note at its true value. High and low notes are all treated alike. The volume and quality delivered will be a revelation.

AMERICAN SALES COMPANY, 19-21 WARREN STREET, NEW YORK CITY

WRIGHT-DeCOSTER

DYNAMIC REPRODUCER

"The Speaker of the Year"

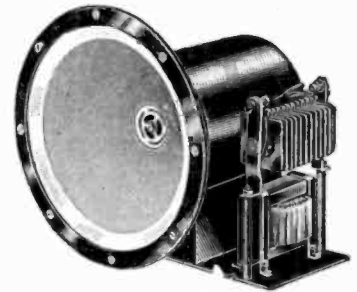

No. 108 Chassis
**LARGEST, GREATEST
MAGNETIC FIELD**

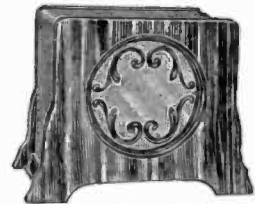

Cabinet "B"
MOST POWERFUL
Handles 250 Push-Pull with ease

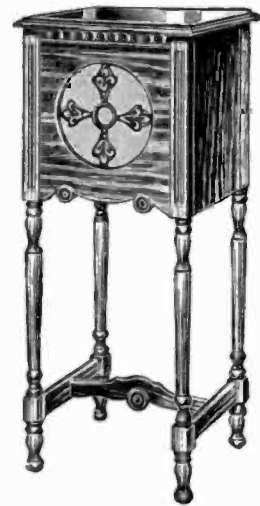

Cabinet "C"
TRUEST REPRODUCTION
Has No Filter of Any Kind
Write for Circular describing different Models

Pacific Coast Representatives

L. P. BRUSH
1256 Howard Street
San Francisco

W. E. SMITH
336 E. 26th St. N.
Portland, Oregon

CARL STONE
506 Allied Crafts Bldg., Los Angeles

WRIGHT-DeCOSTER
ST. PAUL, MINN.

END RADIO BOTHERS

DO YOU KNOW what's wrong when your radio set isn't working right? Ten to one, you don't. Twenty to one, you would if you had a copy of

Hoff's Radio Trouble Finder

Ever hear of M. M. Hoff, radiotrician, of Philadelphia? He was one of the very first "radio bugs" and has been building and studying sets ever since. And now, out of his broad experience, this man has written a book to tell radio owners how to keep their sets working right.

He tells in plain words and illustrations how a set is made, what the parts are called, what are the few usual troubles and how to fix them. Then he lists 103 troubles that sometimes happen and tells how to detect and fix each one.

The book is a regular cyclopedia of radio information—only it's in a language anyone can understand. Read it five minutes and you'll know more about radio than you ever dreamed of.

It will save you many a repair man. It will save you hours of guessing and fussing and fuming. It will help you to keep the tone of your set always sweet and strong. It will keep you from losing many programs. And, best of all—

IT WILL MAKE YOU STOP SWEARING—MUCH TO THE SURPRISE OF YOUR FAMILY— because radio repairs are expensive. Why hire them done when you can easily learn how to keep your set from needing them?

All It Costs Is \$1

Send cash with your order and you get also a Dictionary of Radio Terms and the latest list of Radio Broadcasting Stations with call letters and the new Federal Radio Commission wave lengths. Send your dollar today while the copies last. Six copies for \$4.00.

CHICAGO BARGAIN STORES

426 Quincy Building, Desk 5 Chicago, Ill.

STATEMENT OF OWNERSHIP, MANAGEMENT, CIRCULATION, ETC., REQUIRED BY THE ACT OF CONGRESS OF AUGUST 24, 1912.

"RADIO," published monthly at San Francisco, Calif., for October 1st, 1928.

State of California, County of San Francisco, ss.

Before me, a Notary Public in and for the State and county aforesaid, personally appeared H. W. Dickow, who, having been duly sworn according to law, deposes and says that he is the Business Manager of "RADIO," and that the following is, to the best of his knowledge and belief, a true statement of the ownership, management, etc., of the aforesaid publication for the date shown in the above caption, required by the Act of August 24, 1912, embodied in section 443, Postal Laws and Regulations, printed on the reverse of this form, to-wit:

1. That the names and addresses of the publisher, editor, managing editor, and business managers are:

Publisher, Pacific Radio Publishing Co., Pacific Bldg., San Francisco; Editor, Arthur H. Halloran, Berkeley, Calif.; Managing Editor, None; Business Manager, H. W. Dickow, Pacific Bldg., San Francisco.

2. That the owner is:

Pacific Radio Publishing Co., Pacific Bldg., San Francisco; Arthur H. Halloran, Berkeley, Calif.; H. W. Dickow, Pacific Bldg., San Francisco; H. L. Halloran, Berkeley, Calif.

3. That the known bondholders, mortgagees, and other security holders owning or holding 1 per cent or more of total amount of bonds, mortgages, or other securities are: None.

4. That the two paragraphs next above, giving the names of the owners, stockholders, and security holders, if any, contain not only the list of stockholders and security holders as they appear upon the books of the company but also, in cases where the stockholder or security holder appears upon the books of the company as trustee or in any other fiduciary relation, the name of the person or corporation for whom such trustee is acting, is given; also that the said two paragraphs contain statements embracing affiant's full knowledge and belief as to the circumstances and conditions under which stockholders and security holders who do not appear upon the books of the company as trustees, hold stock and securities in a capacity other than that of a bona fide owner and this affiant has no reason to believe that any other person, association, or corporation has any interest direct or indirect in the said stock, bonds or other securities than as so stated by him.

H. W. DICKOW,
Business Manager.

Sworn to and subscribed before me this 24th day of September, 1928.

(SEAL) JOHN L. MURPHY,

Notary Public in and for the City and County of San Francisco, State of California. My commission expires May 20th, 1929.

\$1.00 Brings the Next Six Issues of "RADIO" to your address

RADIOADS

A CLASSIFIED ADVERTISING SECTION READ BY BETTER BUYERS

The rate per word is eight cents net. Remittance must accompany all advertisements. Include name and address when counting words.

Ads for the January Issue Must Reach Us by December Fifth

IMAGINE AN ORGANIZATION with over 4,000 clients scattered throughout the world, all radiowise dealers, builders, experimenters, hams. Over \$50,000.00 stock of high grade receiving and transmitting parts only, no sets. Spend \$5,000.00 yearly on our own experimenting. Carry nothing until it passes our tests. 50c brings prepaid over four pounds catalog, circuits, data, etc. Weekly data (more than all radio magazines together)—20 weeks, \$1.00; 52 weeks, \$2.50. Sample "Over The Soldering Iron," 32-page experimenter's magazine, 25c. Full trade discounts to licensed hams and radiowise builders. We carry approved items advertised in RADIO. Kladag Radio Laboratories, Established 1920, Kent, Ohio.

BUY OF YOUR BOOKDEALER, or send \$3.50 check or money order to us, for Fourth Edition of "Radio Theory and Operating," by Mary Texanna Loomis, President, Loomis Radio College; member Institute of Radio Engineers. 992 pages, 800 illustrations, flexible binding. Thoroughly revised, down to date. Used by all leading radio schools in this country and Canada, also many universities, technical colleges, high schools, and all U. S. Government radio schools. Highly endorsed by hundreds of experts, amateurs and fans. The best radio text and reference book ever published. Your radio library is not complete without it. Price \$3.50, postage paid. Loomis Publishing Company, Dept. 12, Washington, D. C.

CHEM RAD RADIO CHEMICAL OUTFIT.—Experimenters, you should know radio chemistry, the alluring, thrilling, new science. Complete outfit includes chemicals, metals, apparatus, instructions sufficient to carry on chemical and radio experiments, even television. Send \$4.98 money order or sent C. O. D. Satisfaction guaranteed. Chemical Radio Co., 4730G Drexel Blvd., Chicago.

NAVY SURPLUS offered at fraction of original cost. General Electric 24/1500, 24/750, 12/350 volt. Holtzer-Cabot 12/500, Westinghouse 10/350. Battery driven also adapted for external drive. 500 and 900 cycle generators. All ball bearing. Literature. Henry Kienzle, 501 East 84th Street, New York.

ALFALFA SEEDS, hardy common varieties, \$8.40, \$10.20, \$12.60 bushel; Grimm variety Alfalfa seed \$18. Scarified sweet clover \$3.90, \$5.20; Alsike or red clover \$15. Bags Free. Send for samples and catalogue. Kansas Seed Co., Salina, Kan. (4T)

FOR SALE—Atwater Kent Model 12, \$8.00; LC28 Radio set less cabinet and auto transformers, \$18.00. Western Electric Push-Pull power amplifier Model 7-A, with new tubes, \$18.00. Two Willard large size "B" batteries, nearly new, \$4.00 each. Dewey Ashford, Tudor, Calif.

WANTED—Men to work with National Radio Service organization. No selling scheme. Radio Doctors, Inc., Dept. R, Essex St., Salem, Mass.

MAKE MONEY WITH PATENTS! We offer patents with money-making possibilities; circular free. Floyd Clymer, Denver, Colo. (3T)

RADIO STATION stamps bought, sold and exchanged. Chas. A. Phildius, 510 East 120th St., New York, N. Y. (3T)

FOR SALE—Latest model Best's Shielded Grid Super without cabinet. Perfect condition. \$100. Address Owner, 1129 Mandana Blvd., Oakland, Cal.

BIG PAY—South American work. American firms pay fare, expenses. South American Service Bureau, 14,600 Alma, Detroit, Mich.

FOR SALE—AMATRAN—New, A, B and C; Hi-power box; type 21-A. Cost \$116.00; will sell for \$75.00. D. Bell, 641 Larkin St.

BIG PAY: South American work. American firms pay fare, expenses. South American Service Bureau, 14,600 Alma, Detroit, Mich.

NEW LOG BOOK

Corrected to Nov. 11. With all new allocations. 25 CENTS POSTPAID
"RADIO," Pacific Bldg., San Francisco

GENUINE **Nathaniel BALDWIN** Regular \$9.00 Famous Type C HEADPHONES



We offer several thousand genuine Nathaniel Baldwin PERFECT Type C headphones fresh from the factory in original sealed cartons at a fraction of their cost. Never before sold for less than \$9. Price while they last only \$5.50, satisfaction guaranteed or money refunded.

OUR PRICE \$5.50

ORDER NOW

BALDWIN HEADPHONES hold all long distance records; you simply cannot get distance by any other means. An operator at San Francisco picked up a code message from Bagdad, Turkey, half way around the globe, a world's record. Whether you are a professional operator, amateur, experimenter, set builder or B. C. L., these are the headphones you need.

PREMIER ELECTRIC COMPANY
133-135 West 21st St. New York

SILVER THE KING

24 Kt Gold
Pure Silver
Soft
Copper

Gosilco Super Aerial Wire

Gold over Silver on Copper

Greatly Increased DX Range. 50% More Volume—Clearer Tone—35% Sharper Tuning—Non-Corrosive. Endorsed by Naval Research Laboratory. Gerald M. Best, Major Mott, Ormiston, Van Buren, World's DX Champion. A permanent investment. No. 14, 100 ft., \$4.00; 75, \$3.25; 50, \$2.50. Pat. applied for. If dealer cannot supply you, write or phone us. Over 50,000 GOSILCO Aerials in use—There's a Reason.

GOSILCO RADIO PRODUCTS CO.

6420 Marbrisa Ave. DE. 3940 Huntington Park, Calif.

Northern California Customers Order Your
GOSILCO SUPER AERIAL WIRE FROM

Radio Dealers Supply Service

Wholesale Division of



1452 Market Street

San Francisco, Calif.

Bargains; ARMY AND NAVY RADIO SURPLUS

Motor-Generators— $\frac{1}{4}$, $\frac{1}{2}$, 1, 2, 5 kilowatt; Input 120 D.C.; Output 250 A.C.; 500 cycle—\$25 up. Crocker-Wheeler, Holtzer-Cabot, Westinghouse.

Motor-Generators— $\frac{1}{2}$, 2, 5 kilowatt. Input 120 D.C. Output 600 D.C. Westinghouse, G. E., Crocker-Wheeler.

Dynamotors—6 volt (60 amp.) input, 400 volt, output "Sperry." \$15.00 each.

Transformers—120 and 240 primary—11,500 secondary 500-cycle—

$\frac{1}{2}$ k.w. \$5	} Marconi, Amer. Trans. Co., Wireless Specialty Co.
1 k.w. \$10	
2 k.w. \$25	
5 k.w. \$25	

Rheostats—Ward-Leonard, Vitrohm, Variable. 12 amp.—6 ohm \$3.00.

Gasoline Engines—1, 2, 4 cylinder. \$25, \$50, \$75.

Condensers—Leyden jar—cap. .002 voltage breakdown 10,000, \$2.00 each.

Condensers—"Dubilier" Mica, .002, .004.

Quenched spark gap racks and plates.

G. E., Weston and Westinghouse Meters—specially priced.

Thousands of items for laboratory use.

Write us your requirements and for Catalog in preparation

MANHATTAN ELECTRICAL BARGAIN HOUSE

DEPT. X, 105-7 FULTON ST., N. Y. C.

BE AN EXPERT RADIO OPERATOR

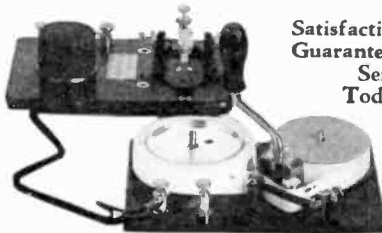

Satisfaction Guaranteed Send Today

MIDGET TELEPLEX

Just like having an expert operator in your home
CODE SENDER Only \$3.50 Postpaid

Good pay. Travel. Excitement. Adventure. This wonderful instrument will teach you to read the code like an expert in half the usual time. Reproduces actual sending of expert operators. Sends messages, radiograms, newspaper matter, etc.—regular code traffic anywhere, anytime and at any speed. All you have to do is listen. Easy and fascinating. Waxed tape-records carry complete instructions. Just what you need for home practice. Why delay when you can get this simple, practical and efficient code sender with lessons for only \$3.50 or with high-frequency key and buzzer for \$5.50. Postpaid.

TELEPLEX CO., 74-76 Cortlandt St., N. Y., N. Y.

FERRANTI Audio Frequency TRANSFORMERS and RADIO PRODUCTS

receive preference by engineers who KNOW

Real audio transformers with flat curves. Special output transformers for all speakers and tubes. High grade iron core chokes for "B" Eliminators. Three range portable meters. 1,000 ohms per volt. 10/50/250 scale. Three range portable meters. 200 ohms per volt. 150/7 $\frac{1}{2}$ volt and 15 Mill. scale with switch. By-Pass condensers—2MF—400 volt and 200 volt.

Circulars sent on request

Send 15c in coin for copy of 1929 Ferranti Year Book

FERRANTI, Inc.

130 West 42nd St. New York, N. Y.

Ferranti, Ltd.
Hollinwood
England

Ferranti Electric Limited
Toronto, Canada

GET THE MOST OUT OF YOUR RADIO SET OR TESTER WITH NA-ALD PRODUCTS

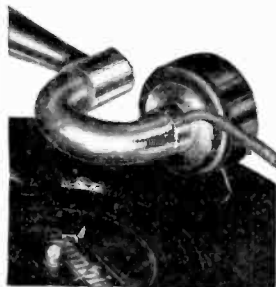

No. 502, \$5.00



No. 481-XS, 65c



No. 426, 50c

"THERE is never a product made but what it can be improved." With this thought in mind NA-ALD has developed a line of related accessories, each of which helps to improve and get more out of your radio set or equipment. The NA-ALD Electric Pickup, simple and inexpensive, can be attached to any radio set and phonograph. It electrically reproduces music from the records through the radio set and speaker. If the quality of the radio set is good, results equal to talking machines costing several hundred dollars can be obtained. Every set owner should have one—it costs only \$5.00 and is sold on a three day trial and money back guarantee.

Fourteen different NA-ALD sockets fill every socket need. They are made in four and five prong models for mounting above or below metal, wood or bakelite sub panels and base boards. Note the beautifully colored locator rings to guide the tube prongs into the holes and to serve as a guide, telling which tube goes in which socket. Green for detector—Orange for power—Red for all purpose—and Yellow for rectifiers. Use NA-ALD spring sockets for detector and screen grid tubes. "It's the contact that counts."



No. 999, \$1.00



No. 934, \$1.25



No. 428, 25c



No. 947, \$1.50

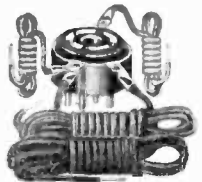

No. 952, \$1.75

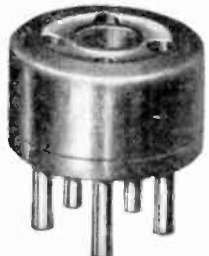

No. 945, \$1.00

NA-ALD adapters fill every need—the only complete line in the world—over fifty-eight different kinds. No. 999 puts UX tubes in UV 199 sockets—No. 934 oscillation control adapters prevent sets squealing or oscillating. No. 947 is recommended by the Victor Talking Machine Company for connecting Radiola No. 16, 17 and 18 or other sets to Victor Electrolas. No. 952 connects A.C. sets to Power Amplifiers such as Samson, Ammertram, etc. No. 945 permits readings with D.C. testers from A.C. sets. No. 954 tests five prong tubes in D.C. testers. No. 421X puts UX tubes in Radiola 111 and 111A sets and is recommended by R.C.A. No. 949 connects electric pickups or volume controls to A.C. or D.C. sets. These are just a few of the things NA-ALD accessories will do. Get the complete NA-ALD catalog and order the NA-ALD products you need.



No. 954, \$1.00



No. 949, 60c



No. 421X, 75c

AT ALL GOOD DEALERS OR WRITE DIRECT

ALDEN MANUFACTURING CO.
Brockton, Mass. Dept. RD2
Please send me the Booklets marked
 THE SOCKET STORY.
 COMPLETE NA-ALD CATALOG.

NAME.....
STREET.....
CITY..... STATE.....

USE THE CLASSIFIED ADS IN "RADIO"

They Bring Results

Mail Your "Ad" Now

Before Buying any "A" Eliminator

Get my authorized Discount Card and complete description of the finest "A" Power Kit ever offered.

DAVID W. KNAPP, Pres.

Knapp Electric, Inc.
Division of P. R. Mallory & Co., Inc.
Room 416, 350 Madison Ave., N. Y. C.

Free

A Continental Control Switch will be given free with a one year subscription to RADIO (\$2.50) if you act immediately. Only a few on hand.

"RADIO"

Pacific Building

San Francisco

Tell them you saw it in RADIO

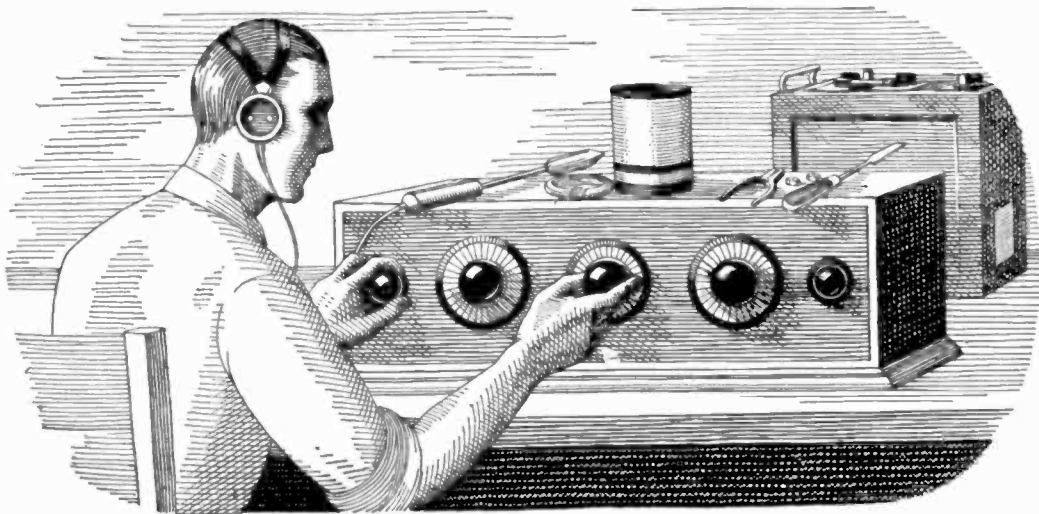

If all the Radio sets I've "fooled" with in my time were piled on top of each other, they'd reach about halfway to Mars. The trouble with me was that I thought I knew so much about Radio that I really didn't know the first thing. I thought Radio was a plaything—that was all I could see in it for me.

I Thought Radio Was a Plaything

But Now My Eyes Are Opened, And I'm Making Over \$100 a Week!

\$50 a week! Man alive, just one year ago a salary that big would have been the height of my ambition.

Twelve months ago I was scrimping along on starvation wages, just barely making both ends meet. It was the same old story—a little job, a salary just as small as the job—while I myself had been dragging along in the rut so long I couldn't see over the sides.

If you'd told me a year ago that in twelve months' time I would be making \$100 and more every week in the Radio business—whew! I know I'd have thought you were crazy. But that's the sort of money I'm pulling down right now—and in the future I expect even more. Why only today—

But I'm getting ahead of my story. I was hard up a year ago because I was kidding myself, that's all—not because I had to be. I could have been holding then the same sort of job I'm holding now, if I'd only been wise to myself. If you've fooled around with Radio, but never thought of it as a serious business, maybe you're in just the same boat I was. If so, you'll want to read how my eyes were opened for me.

When broadcasting first became the rage, several years ago, I first began my dabbling with the new art of Radio. I was "nuts" about the subject, like many thousands of other fellows all over the country. And no wonder! There's a fascination—something that grabs hold of a fellow—about twirling a little knob and suddenly listening to a voice speaking a thousand miles away. Twirling it a little more and listening to the mysterious dots and dashes of steamers far at sea. Even today I get a thrill from this strange force. In those days, many times I stayed up almost the whole night trying for DX. Many times I missed supper because I couldn't be dragged away from the latest circuit I was trying out.

I never seemed to get very far with it, though. I used to read the Radio magazines and occasionally a Radio book, but I never understood the subject very clearly, and lots of things I didn't see through at all.

So, up to a year ago, I was just a dabbler—I thought Radio was a plaything. I never realized what an enormous, fast growing industry Radio had come to be—employing thousands and thousands of trained men.

I usually stayed home in the evenings after work, because I didn't make enough money to go out very much. And generally during the evening I'd tinker a little with Radio—a set of my own or some friend's. I even made a little spare change this way, which helped a lot, but I didn't know enough to go very far with such work.

And as for the idea that a splendid Radio job might be mine, if I made a little effort to prepare for it—such an idea never entered my head. When a friend suggested it to me one year ago, I laughed at him.

"You're kidding me," I said.

"I'm not," he replied. "Take a look at this ad."

He pointed to a page ad in a magazine, an advertisement I'd seen many times but just passed up without thinking, never dreaming it applied to me. This time I read the ad carefully. It told of many big opportunities for trained men to succeed in the great new Radio field. With the advertisement was a coupon offering a big free book full of information. I sent the coupon in, and in a few days received a handsome 64-page book, printed in two colors, telling all about the opportunities in the Radio field and how a man can prepare quickly and easily at home to take advantage of these opportunities. Well, it was a revelation to me. I read the book carefully, and when I finished it I made my decision.

What's happened in the twelve months since that day, as I've already told you, seems almost like a dream to me now. For ten of those twelve months, I've had a Radio business of my own. At first, of course, I started it as a little proposition on the side, under the guidance of the National Radio Institute, the outfit that gave me my Radio training. It wasn't long before I was getting so much to do in the Radio line that I quit my measly little clerical job, and devoted my full time to my Radio business.

Since that time I've gone right on up, always under the watchful guidance of my friends at the National Radio Institute. They would have given me just as much help, too, if I had wanted to follow some other line of Radio besides building my own retail business—such as broadcasting, manufacturing, experimenting, sea operating, or any one of the score of lines they prepare you for.

And to think that until that day I sent for their eye-opening book, I'd been wailing "I never had a chance!"

Now I'm making, as I told you before, over \$100 a week. And I know the future holds even more, for Radio is one of the most progressive, fastest-growing businesses in the world today. And it's work that I like—work a man can get interested in.

Here's a real tip. You may not be as bad off as I was. But think it over—are you satisfied? Are you making enough money, at work that you like? Would you sign a contract to stay where you are now for the next ten years—making the same money? If not, you'd better be doing something about it instead of drifting.

This new Radio game is a live-wire field of golden rewards. The work, in any of the 20 different lines of Radio, is fascinating, absorbing, well paid. The National Radio Institute—oldest and largest Radio home-study school in the world—will train you inexpensively in your own home to know Radio from A to Z and to increase your earnings in the Radio field.

Take another tip—no matter what your plans are, no matter how much or how little you know about Radio—clip the coupon below and look their free book over. It is filled with interesting facts, figures, and photos, and the information it will give you is worth a few minutes of anybody's time. You will place yourself under no obligation—the book is free, and is gladly sent to any one who wants to know about Radio. Just address J. E. Smith, President, National Radio Institute, Dept. 44-R, Washington, D. C.

J. E. SMITH, President,
National Radio Institute,
Dept. 44-R, Washington, D. C.
Dear Mr. Smith:

Please send me your 64-page free book, printed in two colors, giving all information about the opportunities in Radio and how I can learn quickly and easily at home to take advantage of them. I understand this request places me under no obligation, and that no salesman will call on me.

Name.....
Address.....
Town..... State.....
Occupation.....

TOBE

Convert charger into "A" Eliminator
in less than a minute



ANY standard charger such as a Tungar, Rectagon, bulb or electrolytic, etc., can be converted in less than a minute to a four or six volt A eliminator by using a TOBE A FILTER.

Tobe A filter is a development consisting of 8000 Mfd. of dry condenser and two chokes mounted in a container.

This combination, a charger and a Tobe A filter, does away with your messy A battery forever.

AND THIS



*Will take the hum out of
your dynamic speaker*

Both units guaranteed to operate faithfully

TOBE A Filter..... List Price \$18.00

TOBE A Condenser..... List Price 6.00

Tobe Deutschmann Co.

ENGINEERS, MANUFACTURERS AND IMPORTERS OF TECHNICAL APPARATUS

CANTON, MASS.

NEW YORK

CHICAGO

THE MECHANICAL MASTERPIECE

NEW 1929

Browning-Drake

EIGHT IN LINE

Eight tubes in line—aluminum construction throughout—all power equipment an integral part of chassis—this year's masterpiece of mechanical precision.

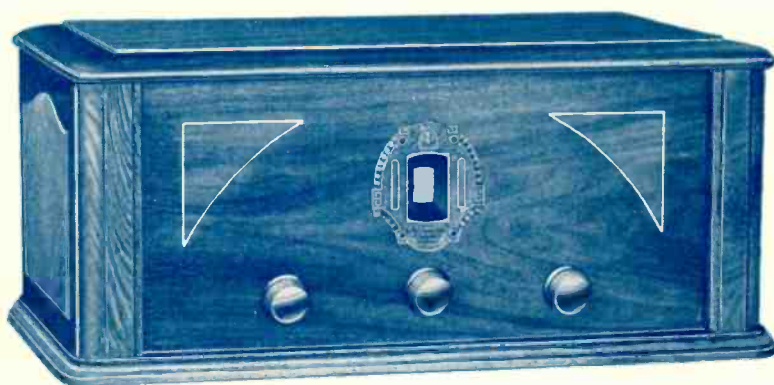

Special Browning-Drake circuit, famous for tone quality and distance—cabinet of selected walnut with hand-rubbed Duco finish. List \$135.00.

In radio sets, as in most everything else, you get about what you pay for. The cheapest is never the best.

Your customers are willing to pay a little more and get a Browning-Drake.

Refinements, which make for beauty, power, and tone quality, are obtained through precision assembly, rather than mass production. Among those who appreciate and require the best, Browning-Drake is the outstanding choice.

Quality never fails to satisfy.

BROWNING TRADE MARK DRAKE

Press of
THE JAMES H. BARRY COMPANY
SAN FRANCISCO, U. S. A.